

Lantech

IPES-5408S-X Series

8 10/100TX D-coded + 4 10/100/1000T X-coded L2⁺ w/8 PoE at/af
Industrial Managed Switch w/Enhanced G.8032 Ring

User Manual (Hardware)



Dec. 2017

Recommendation for Shielded network cables

STP cables have additional shielding material that is used to reduce external interference. The shield also reduces the emission at any point in the path of the cable. Our recommendation is to deploy an STP network cable in demanding electrical environments. Examples of demanding indoor environments are where the network cable is located in parallel with electrical mains supply cables or where large inductive loads such as motors or contactors are in close vicinity to the camera or its cable. It is also mandatory to use an STP cable where the power device (like IP camera) is used outdoors or where the network cable is routed outdoors.



Important Notice

Lantech Communications Global, Inc. reserves the right to modify the equipment, its specification or this manual without prior notice, in the interest of improving performance, reliability, or servicing. At the time of publication all data is correct for the operation of the equipment at the voltage and/or temperature referred to. Performance *data* indicates typical values related to the particular product.

No part of this documentation or information supplied may be divulged to any third party without the express written consent of Lantech Communications Global Inc. Products offered may contain software which is proprietary to Lantech Communications Global Inc. The offer or supply of these products and services does not include or infer any transfer of ownership.

Interference Issues

This Equipment has been tested and found to comply with the limits for a Class A digital device, pursuant to Part 15 of the FCC rules. These limits are designed to provide reasonable protection against harmful interference in a commercial or industrial installation. This equipment generates, uses, and can radiate radio frequency energy. It may cause harmful interference to radio communications if the equipment is not installed and used in accordance with the instructions.

FCC Warning

This Equipment has been tested and found to comply with the limits for a Class-A digital device, pursuant to Part 15 of the FCC rules. These limits are designed to provide reasonable protection against harmful interference in a residential installation. This equipment generates, uses, and can radiate radio frequency energy. It may cause harmful interference to radio communications if the equipment is not installed and used in accordance with the instructions. However, there is no guarantee that interference will not occur in a particular installation. If this equipment does cause harmful interference to radio or television reception, which can be determined by turning the equipment off and on, the user is encouraged to try to correct the interference by one or more of the following measures:

- Reorient or relocate the receiving antenna.
- Increase the separation between the equipment and receiver.
- Connect the equipment into an outlet on a circuit different from that to which the receiver is connected.
- Consult the dealer or an experienced radio/TV technician for help.

CE Mark Warning

This is a Class-A product. In a domestic environment this product may cause radio interference in which case the user may be required to take adequate measures.

Content

Chapter 1 Hardware Description.....	5
1.1 Physical Dimension.....	5
1.2 Package Content:	7
1.3 IP Protection	7
1.4 LED Indicators	10
Chapter 2 Hardware Installation	12
Chapter 4 Network Application.....	18
4.1 ITU G.8032 Scheme.....	18
4.2 Ring Coupling	18
4.3 Multiple Rings	19
4.4 Dual Homing	20
4.5 Chain	20
Chapter 5 Console Management.....	22
5.1 Connecting to the Console Port.....	22
5.2 Login in the Console Interface.....	22

Chapter 1 Hardware Description

In this paragraph, it will describe the Industrial switch's hardware spec, port, cabling information, and wiring installation.

1.1 Physical Dimension

Aluminum case. IP-65,
178mm(W)x99mm(H)x103mm(D)

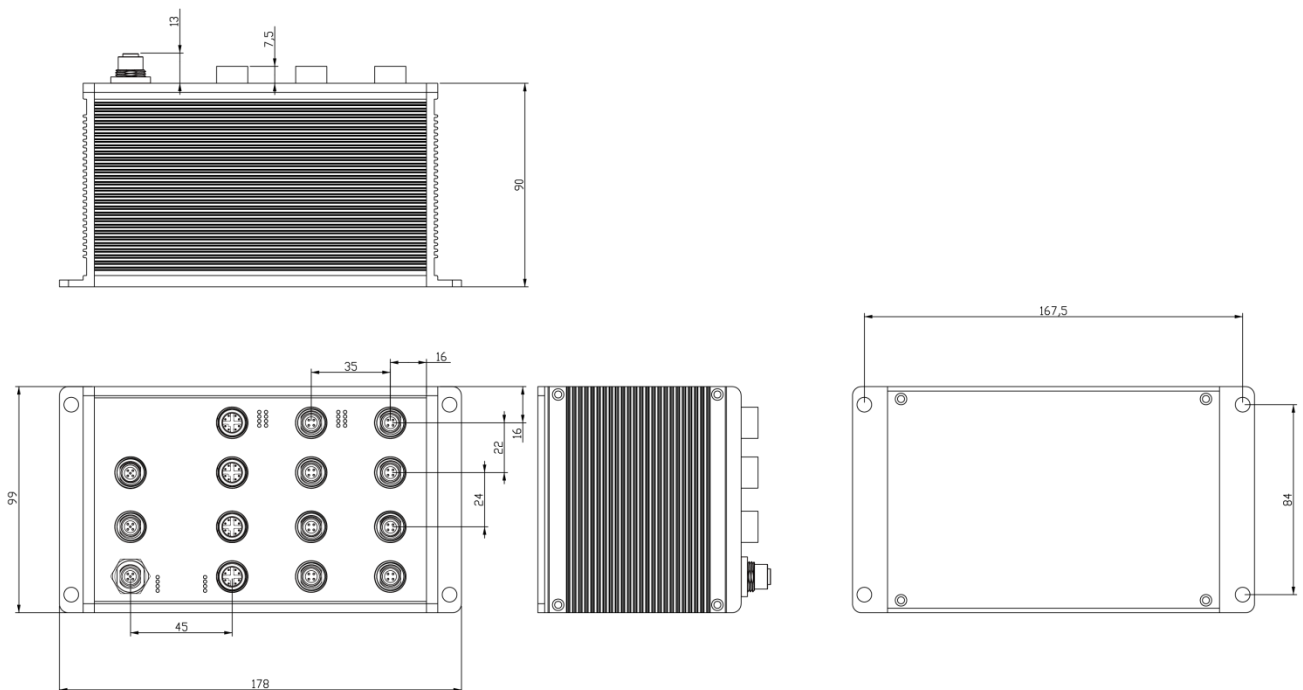

Port description of IP-65 series switch

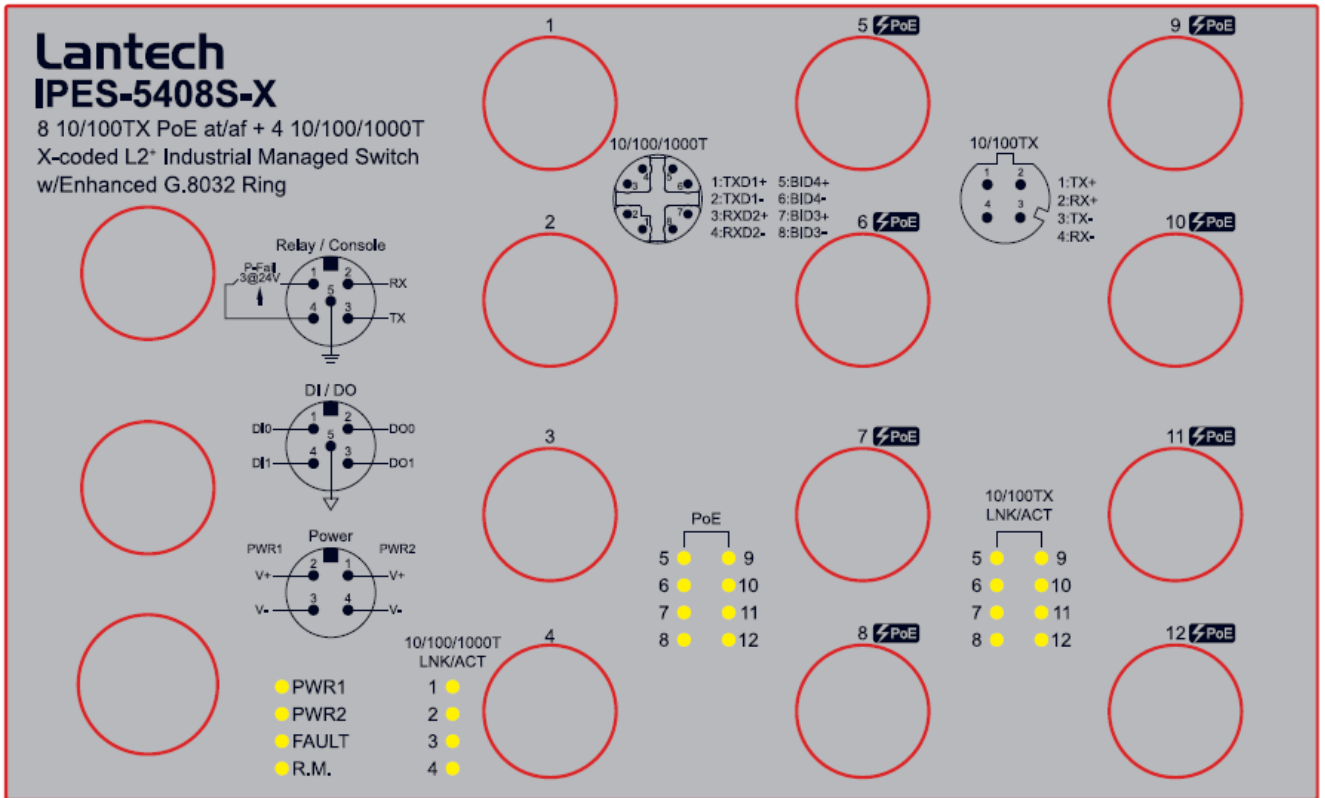

1.2 Package Content:

Industrial Switch x1

Console cable x1

1.3 IP Protection

The **IP Code, Ingress Protection Rating**, sometimes also interpreted as **International Protection Rating**, classifies and rates the degree of protection provided against the intrusion (including body parts such as hands and fingers), dust, accidental contact, and water in *mechanical casings* and with electrical enclosures. It is published by the International Electrotechnical Commission (IEC)

Solid particle protection

The first digit indicates the level of protection that the enclosure provides against access to hazardous parts (e.g., electrical conductors, moving parts) and the ingress of solid foreign objects.

Level	Object size protected against	Effective against
0	—	No protection against contact and ingress of objects
1	>50 mm	Any large surface of the body, such as the back of a hand, but no protection against deliberate contact with a body part
2	>12.5 mm	Fingers or similar objects
3	>2.5 mm	Tools, thick wires, etc.
4	>1 mm	Most wires, screws, etc.
5	Dust protected	Ingress of dust is not entirely prevented, but it must not enter in sufficient quantity to interfere with the

		satisfactory operation of the equipment; complete protection against contact
6	Dust tight	No ingress of dust; complete protection against contact

Liquid ingress protection

The second digit indicates the level of protection that the enclosure provides against harmful ingress of water.

Level	Protected against	Testing for	Details
0	Not protected	—	—
1	Dripping water	Dripping water (vertically falling drops) shall have no harmful effect.	Test duration: 10 minutes Water equivalent to 1 mm rainfall per minute
2	Dripping water when tilted up to 15°	Vertically dripping water shall have no harmful effect when the enclosure is tilted at an angle up to 15° from its normal position.	Test duration: 10 minutes Water equivalent to 3 mm rainfall per minute
3	Spraying water	Water falling as a spray at any angle up to 60° from the vertical shall have no harmful effect.	Test duration: 5 minutes Water volume: 0.7 litres per minute Pressure: 80–100 kPa
4	Splashing of water	Water splashing against the enclosure from any direction shall have no harmful effect.	Test duration: 5 minutes Water volume: 10 litres per minute Pressure: 80–100 kPa

5	Water jets	Water projected by a nozzle (6.3 mm) against enclosure from any direction shall have no harmful effects.	Test duration: at least 15 minutes Water volume: 12.5 litres per minute Pressure: 30 kPa at distance of 3 m
6	Powerful water jets	Water projected in powerful jets (12.5 mm nozzle) against the enclosure from any direction shall have no harmful effects.	Test duration: at least 3 minutes Water volume: 100 litres per minute Pressure: 100 kPa at distance of 3 m
7	Immersion up to 1 m	Ingress of water in harmful quantity shall not be possible when the enclosure is immersed in water under defined conditions of pressure and time (up to 1 m of submersion).	Test duration: 30 minutes Immersion at depth of at least 1 m measured at bottom of device, and at least 15 cm measured at top of device
8	Immersion beyond 1 m	The equipment is suitable for continuous immersion in water under conditions which shall be specified by the manufacturer. Normally, this will mean that the equipment is hermetically sealed. However, with certain types of equipment, it can mean that water can enter but only in such a manner that	Test duration: continuous immersion in water Depth specified by manufacturer

		it produces no harmful effects.	
9	Powerful high temperature water jets	Protected against close-range high pressure, high temperature spray downs.	—

1.4 LED Indicators

The diagnostic LEDs that provide real-time information of system and optional status are located on the front panel of the industrial switch. The following table provides the description of the LED status and their meanings for the switch.

LED	Color	Status	Meaning
R.M	Green	On	The switch unit is owner switch of ITU-Ring
		Off	The switch is not owner switch
PWR1	Green	On	Power 1 is active
		Off	Power 1 is inactive
PWR2	Green	On	Power 2 is active
		Off	Power 2 is inactive
FAULT	Red	On	Power or port failure
		Off	No failure
P5 ~ P12	Link/Ack	On	A network device is detected.
		Blinking	The port is transmitting or receiving packets from the TX device.
		Off	No device attached
	PoE(5~12)	On	The port is operating in PoE mode.
		Off	The port is not operating in PoE mode.

P1 ~ P4	Link/Ack	On	A network device is detected.
		Blinking	The port is transmitting or receiving packets from the TX device.
		Off	No device attached

Chapter 2 Hardware Installation

3.1 Hardware installation

3.1.1 Unpack switch and check the accessory with packing content list

3.1.2 Mount the switch on desired position. For the best ventilation, it is suggested to mount the switch on metallic surface.

3.1.3 Connect the M12 connector of power input.

- Voltage of Power Input

12V model:

The power input voltage can be from 9.5V to 57VDC to feed power on both the 802.3af and 802.3at standardized devices.

WV model:

The power input voltage can be from 16.8V to 137.5VDC to feed power on both 802.3af/at standardized devices.

Please make sure that the external power supply unit you use to provide the PoE voltage meet the following criteria:

- The power consumption can satisfy the total power request from all PD devices required.

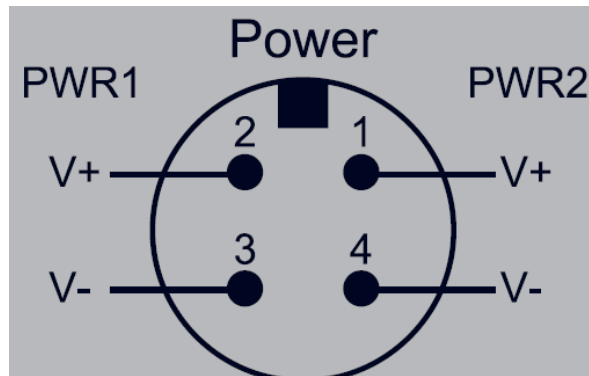

Pin assignment of Power input

■ Dual Power Input

The power input can be supported redundantly. The supply voltage is electrically isolated from the housing.

Note: With single power supply of the mains voltage, the device will report a power failure. You can disable this power fail event via web browser.

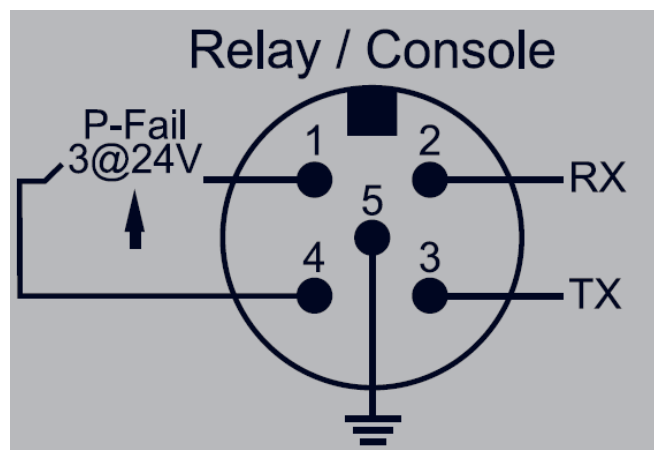

Pin assignment of alarm relay

A break in contact is reported via the relay contact :

- The failure of at least one of the two supply voltages.
- The break link status of at least one switch port.

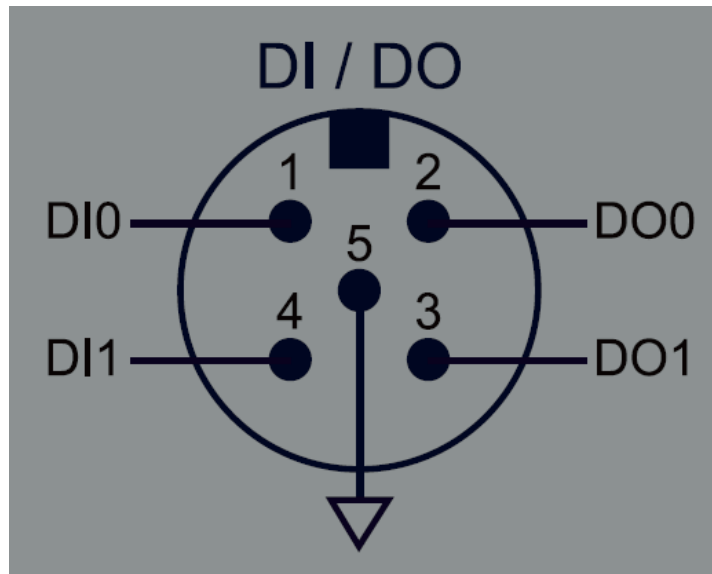

Pin assignment of DI/DO

3.1.4 Fitting the device, grounding

Install the system in a dry and clean area to protect the switch to get exposed with dirt.

Plug the connector to the power supply plug then turn on the power supply.

■ Ground

The chassis is grounded via a separate ground nut (M3).

Use toothed locking washers for a good electrical connection.



Ground screw of IPES-5408S-X switch

3.1.5 Connect the M12 connector with RJ-45 data cable, ports are not used shall be capped that comes with the package to insulate the surrounding.

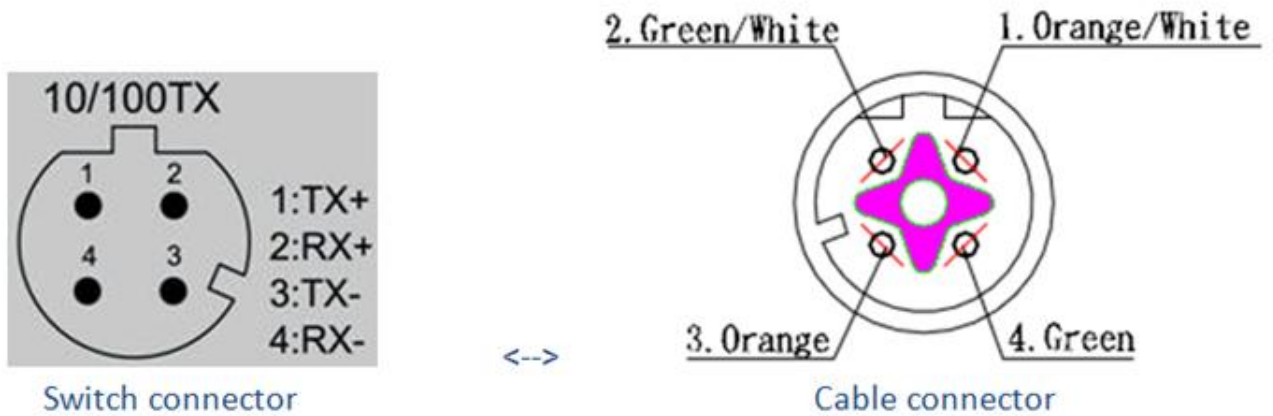

Switch connector

Cable connector

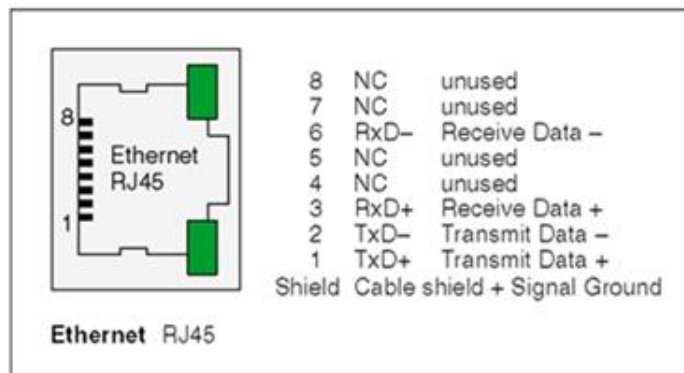

Ethernet RJ45

T-568B

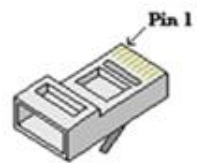
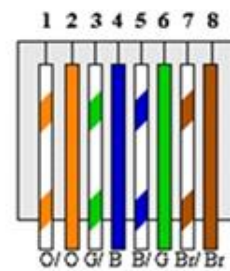

RJ-45 Plug

Pin assignment of M12 10/100Tx network connector

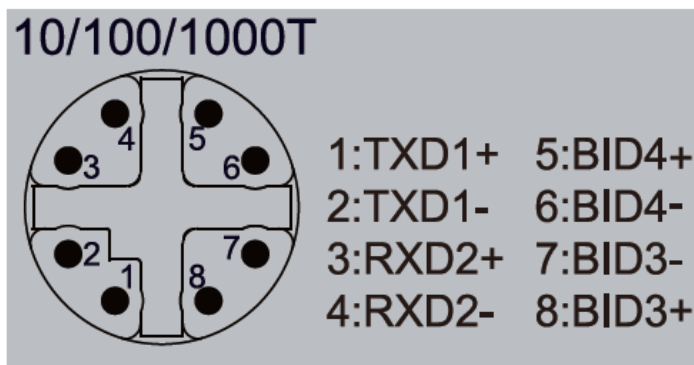

Switch connector

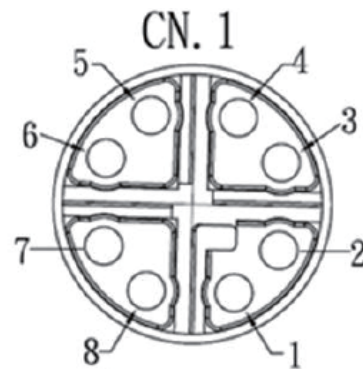

Cable connector

Shell	Gnd	Shell	
1	Orange/ White	1	TWIST
2	Orange	2	
3	Green/ White	3	TWIST
4	Green	6	
5	Brown/ White	7	TWIST
6	Brown	8	
7	Blue/ White	5	TWIST
8	Blue	4	
CN. 1	Wire Color	CN. 2	
	PIN	OUT	

T-568B

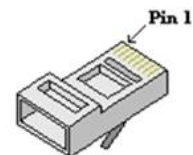
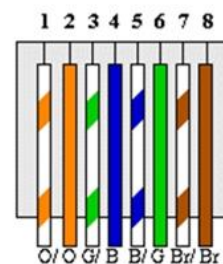

RJ-45 Plug

Pin assignment of M12 10/100/1000T network connector

3.1.6 Check the status of LED, make sure the switch was in working status.

Note:

- The protection class IP65 is only achieved when bolted together.
- The other components attaching to the system have to meet with the IP65 protection class in order to reach the whole system IP65 protection.
- Empty ports must be sealed with the protective caps supplied.

Chapter 4 Network Application

4.1 ITU G.8032 Scheme

LANTECH G.8032 protocol is following ITU (International Telecommunication Unit) G.8032 v2 draft. The benefits of G.8032 are:

1. <50ms recovery time when failover
2. G.8032 has defined the protocol scheme, parameters, functions, test measures to be unified that the users can evaluate the possible network infrastructure without literally testing each brand in large scale.

4.2 Ring Coupling

Redundant Coupling

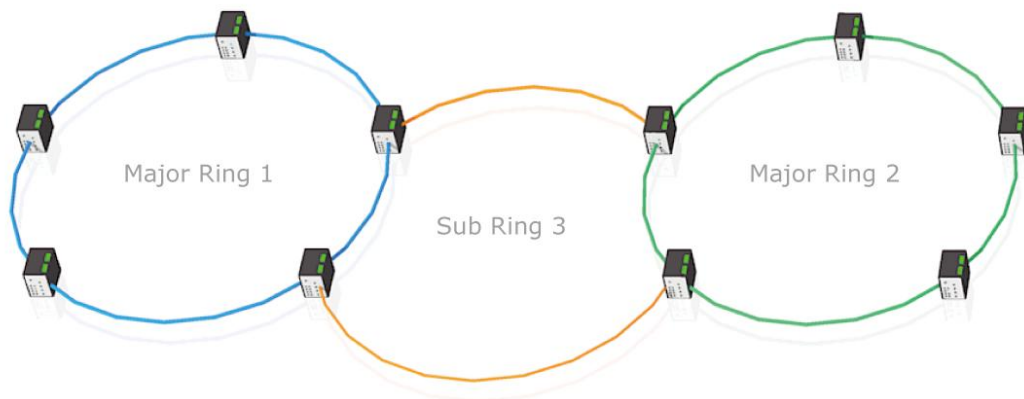

Redundant Coupling with Multiple Rings

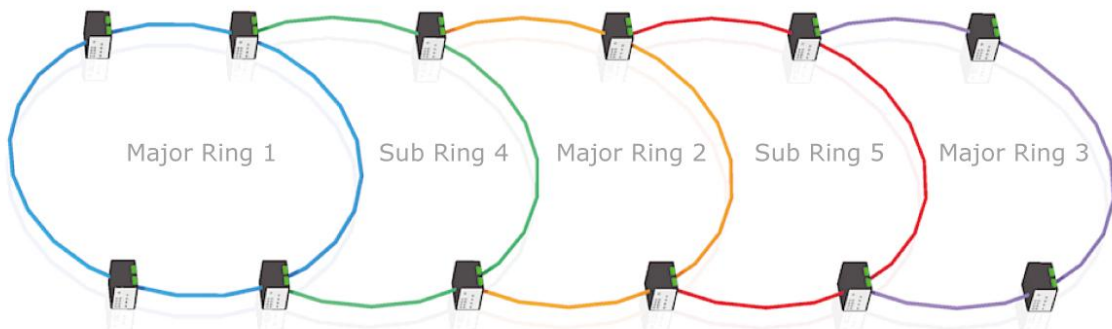

4.3 Multiple Rings

Dual Rings

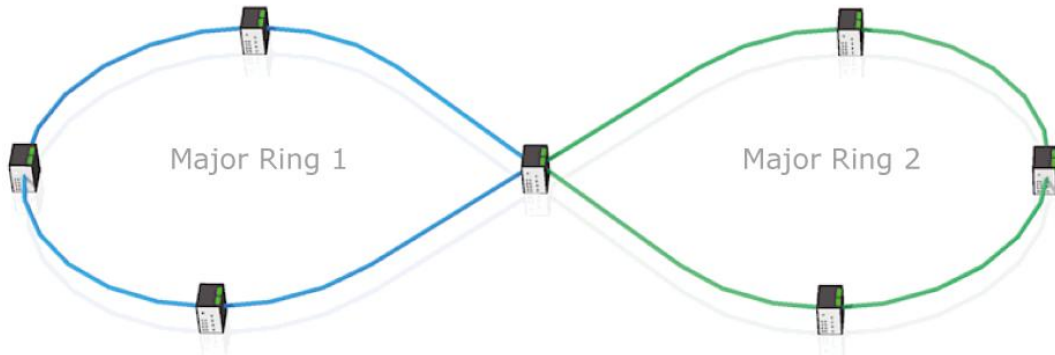

Multiple Rings

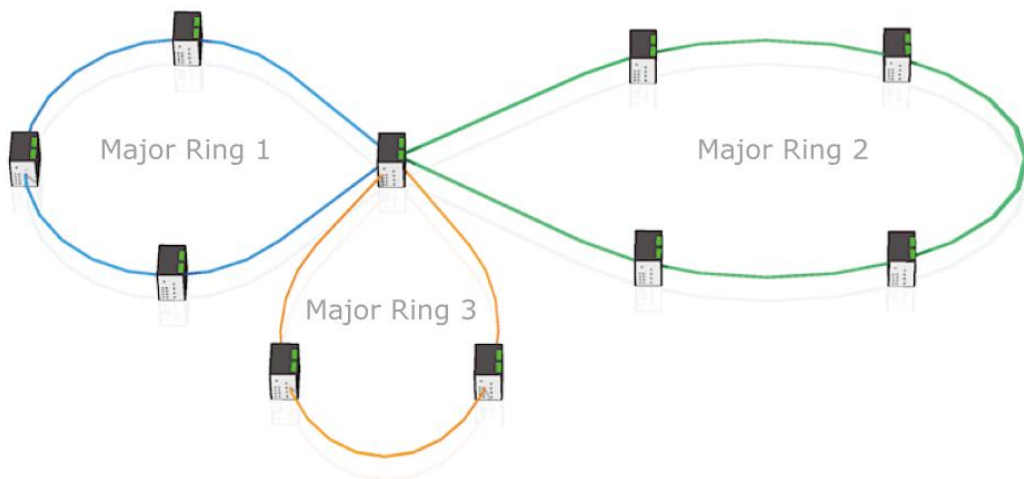

4.4 Dual Homing

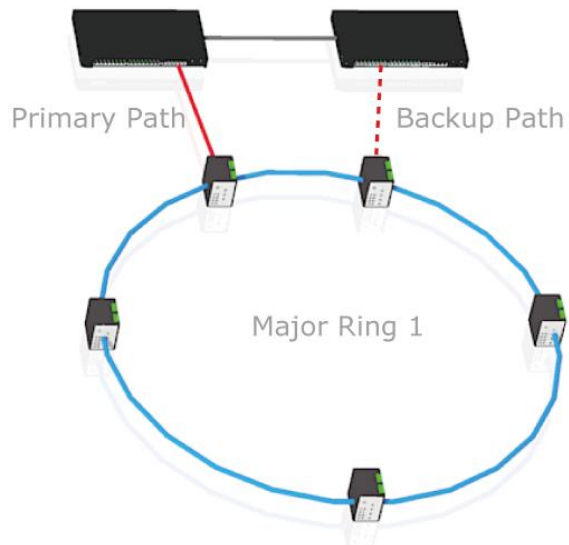

4.5 Chain

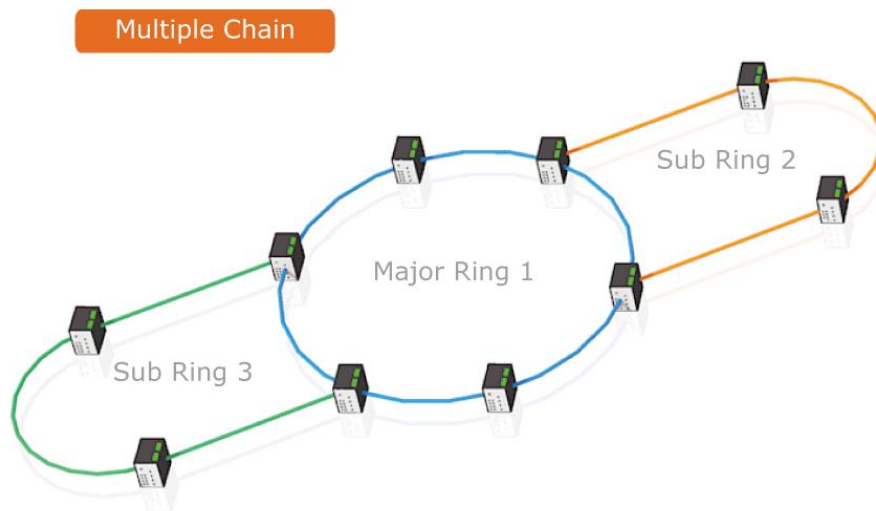

Multiple Chain Share Common Ends

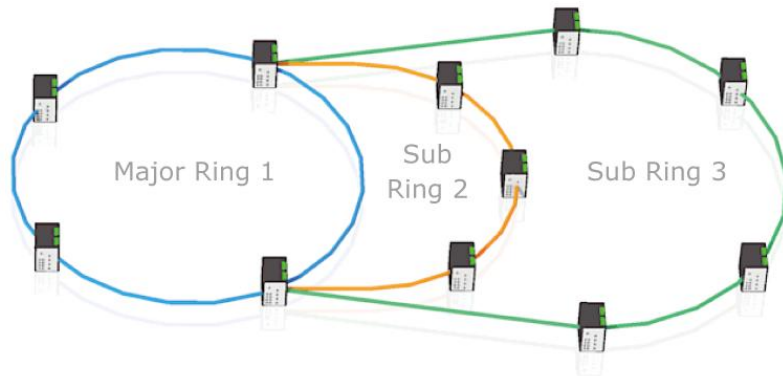

Cascade Chain

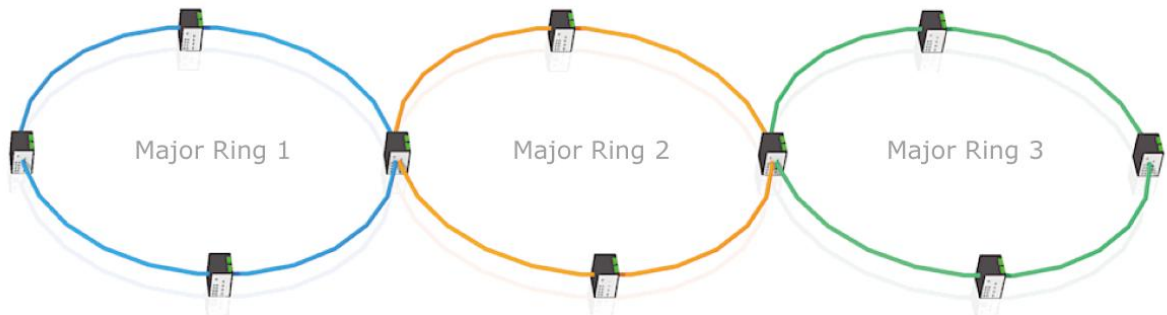

Chain in Chain

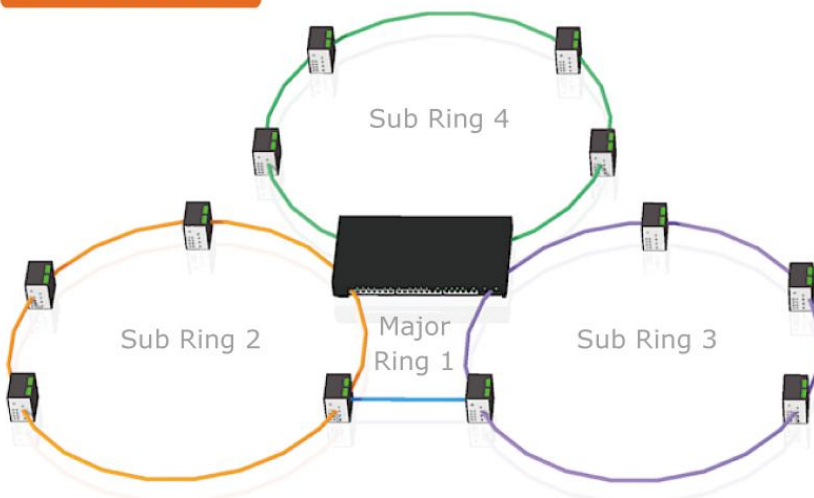

Chapter 5 Console Management

5.1 Connecting to the Console Port

The supplied cable which one end is M12 5-pole connector and the other end is RS-232 connector. Attach the end of RS-232 connector to PC or terminal and the other end of M12 connector to the console port of the switch. The connected terminal or PC must support the terminal emulation program.

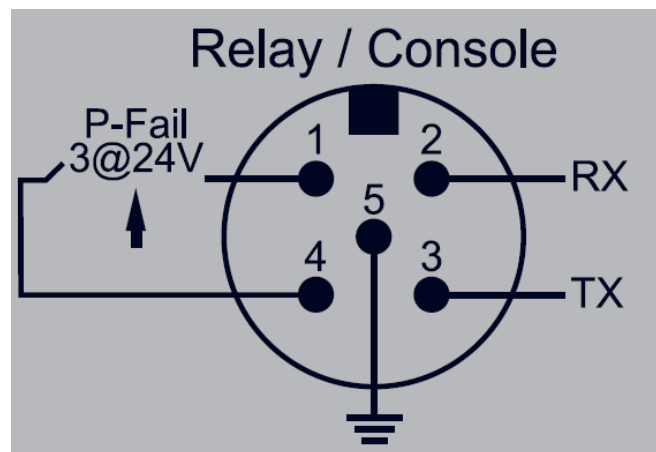

5.2 Login in the Console Interface

When the connection between Switch and PC is ready, turn on the PC and run a terminal emulation program or **Hyper Terminal** and configure its **communication parameters** to match the following default characteristics of the console port:

Baud Rate: 115200 bps

Data Bits: 8

Parity: none

Stop Bit: 1

Flow control: None

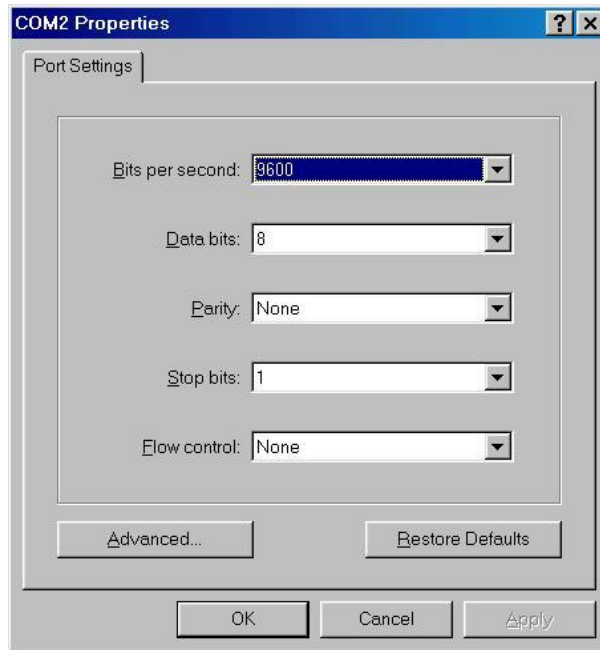

The settings of communication parameters

Having finished the parameter settings, click 'OK'. When the blank screen shows up, press Enter key to have the login prompt appears. Key in 'admin' (default value) for both User name and Password (use **Enter** key to switch), then press Enter and the Main Menu of console management appears. Please see below figure for login screen.

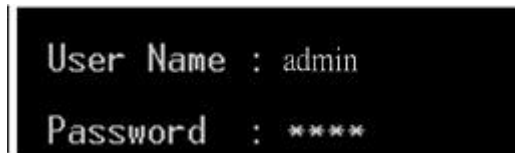

Console login interface

=====Notice=====

For web-based management, please refer to our "Software Management Manual" at <http://www.lantechcom.tw/global/eng/support-downloads.html>