

# Lantech

## IGC-0101DSFP

## IPGC-0101DSFP

10/100/1000T (PoE at) to 100/1000M  
SFP Industrial Switch Converter

---

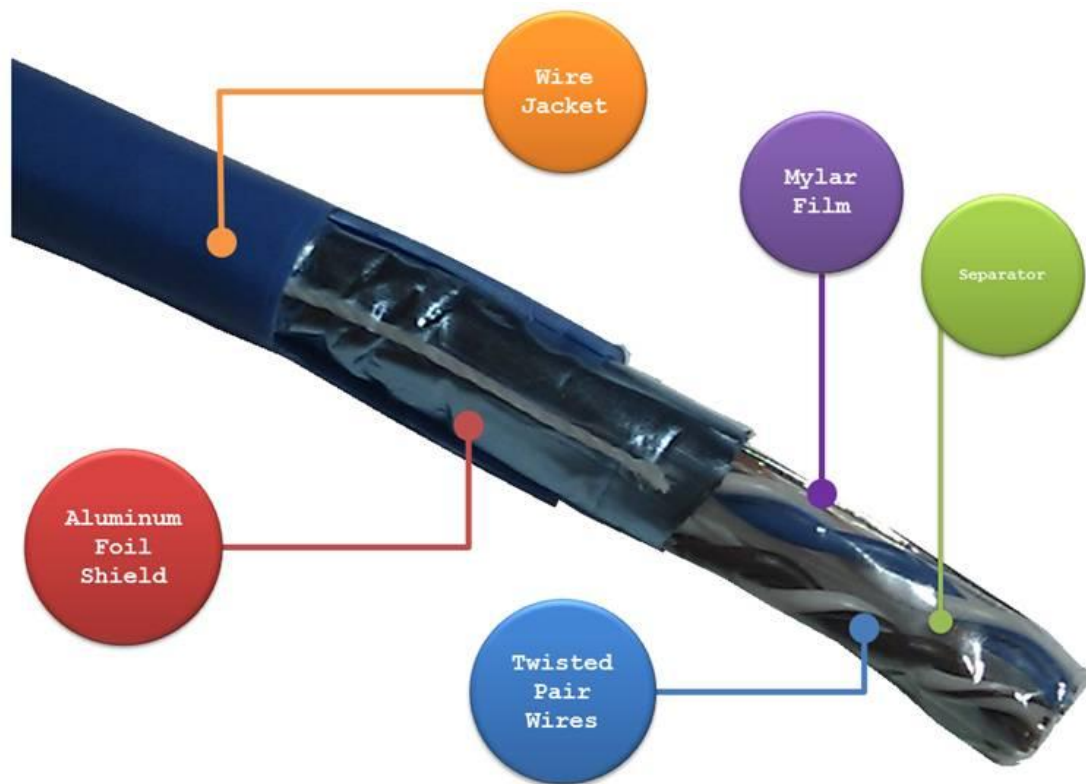
### User Manual



Dec 2016

## Recommendation for Shielded network cables

STP cables have additional shielding material that is used to reduce external interference. The shield also reduces the emission at any point in the path of the cable. Our recommendation is to deploy an STP network cable in demanding electrical environments. Examples of demanding indoor environments are where the network cable is located in parallel with electrical mains supply cables or where large inductive loads such as motors or contactors are in close vicinity to the camera or its cable. It is also mandatory to use an STP cable where the power device (like IP camera) is used outdoors or where the network cable is routed outdoors.



# Content

---

Overview.....	1
Introduction: IGC-0101DSFP .....	1
Introduction: IPGC-0101DSFP.....	2
Packing List.....	3
Safety Precaution.....	3
Hardware Description .....	4
Front Panel.....	4
Top View .....	5
Wiring the Power Inputs .....	5
Wiring the Fault Alarm Contact .....	6
LED Indicators.....	7
DIP-Switch .....	7
Ports.....	8
Cabling .....	9
Mounting Installation .....	13
DIN-Rail Mounting.....	13
Wall Mount Plate Mounting .....	15

Hardware Installation.....	16
Installation Steps.....	16
Troubles shooting .....	18

## **FCC Warning**

This Equipment has been tested and found to comply with the limits for a Class-A digital device, pursuant to Part 15 of the FCC rules. These limits are designed to provide reasonable protection against harmful interference in a residential installation. This equipment generates, uses, and can radiate radio frequency energy. It may cause harmful interference to radio communications if the equipment is not installed and used in accordance with the instructions. However, there is no guarantee that interference will not occur in a particular installation. If this equipment does cause harmful interference to radio or television reception, which can be determined by turning the equipment off and on, the user is encouraged to try to correct the interference by one or more of the following measures:

- Reorient or relocate the receiving antenna.
- Increase the separation between the equipment and receiver.
- Connect the equipment into an outlet on a circuit different from that to which the receiver is connected.
- Consult the dealer or an experienced radio/TV technician for help.

## **CE Mark Warning**

This is a Class-A product. In a domestic environment this product may cause radio interference in which case the user may be required to take adequate measures.

# Overview

---

## Introduction: IGC-0101DSFP

The Lantech IGC-0101DSFP is an Industrial Converter converting from 10/100/1000BaseT to 100/1000M-FX dual speed. It supports 10K bytes jumbo frame.

### **Auto-sensing LLF and Power Fault LED/relay alarm setting by DIP switch**

Featured with LLF (Link Loss Forwarding) function, Lantech IPGC-0101DSFP is able to auto cut off connection if one end of connection is down. When copper port disconnects, it will auto turn off fiber port. When fiber port disconnects, it will auto turn off copper port. Smart LLF function alert central side switch immediate remedy action when connection is lost.

Power Fault LED and relay alarm can be off by DIP switch.

### **Dual power input from 9V~72VDC/18~36VAC with galvanic isolation**

IGC-0101DSFP supports dual wide range input from 9V~72VDC (12V model) and 18~36VAC (AC model) with galvanic isolation that is good for various application including vehicle, railway, solar panel etc.

### **Hardened design with extended temperature range**

It provides  $\pm 2000V$  EFT and  $\pm 6000V$  ESD protection, which can reduce unstable situation caused by power line and Ethernet. It has high reliability and robustness coping with extensive EMI/RFI phenomenon, environmental vibration and shocks usually found in Automation, transportation, surveillance, Wireless backhaul, Semi-conductor factory and assembly lines.

The -E model can be used in extreme environments with an operating temperature range of  $-40^{\circ}C$  to  $75^{\circ}C$ .

## **Introduction: IPGC-0101DSFP**

The Lantech IPGC-0101DSFP is an Industrial Converter converging from 10/100/1000BaseT to 100/1000M-FX dual speed with 802.3at/af PoE support. It supports 10K jumbo frame.

### **Auto-sensing LLF and Power Fault LED/relay alarm setting by DIP switch**

Featured with LLF (Link Loss Forwarding) function, Lantech IPGC-0101DSFP is able to auto cut off connection if one end of connection is down. When copper port disconnects, it will auto turn off fiber port. When fiber port disconnects, it will auto turn off copper port. Smart LLF function alert central side switch immediate remedy action when connection is lost.

Power Fault LED and relay alarm can be off by DIP switch

.

### **Dual DC input power**

IPGC-0101DSFP supports dual input from 9.5V~72VDC (12V model) or 44V~57VDC (48V model) for various application including vehicle, railway, solar panel etc.

### **Hardened design with extended temperature range**

It provides  $\pm 2000V$  EFT and  $\pm 6000V$  ESD protection, which can reduce unstable situation caused by power line and Ethernet. It has high reliability and robustness coping with extensive EMI/RFI phenomenon, environmental vibration and shocks usually found in Automation, transportation, surveillance, Wireless backhaul, Semi-conductor factory and assembly lines.

The -E model can be used in extreme environments with an operating temperature range of  $-40^{\circ}C$  to  $75^{\circ}C$ .

19" Rack mount-able kit for single or dual converter mounting

The optional 19" rack-mount kit can be mounted with single or dual converters.

## **Packing List**

- 1 x 10/100/1000 to Mini-GBIC Industrial Switch Converter
- 1 x Terminal Block

## **Safety Precaution**

*Attention IF DC voltage is supplied by an external circuit, please use a protection device on the power supply input.*



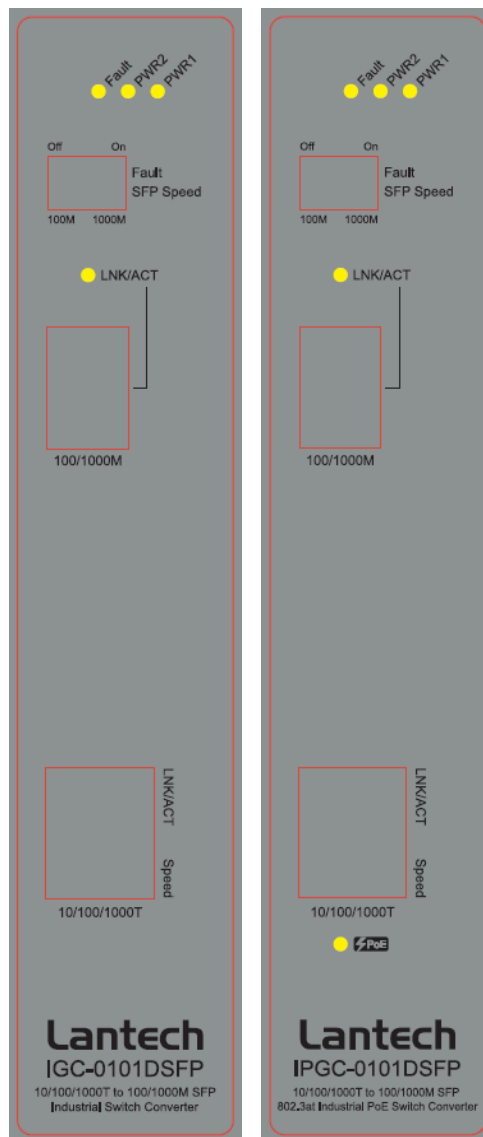
# Hardware Description

---

In this paragraph, we will introduce the Industrial switch converter's hardware spec, port, cabling information, and wiring installation.

## Front Panel

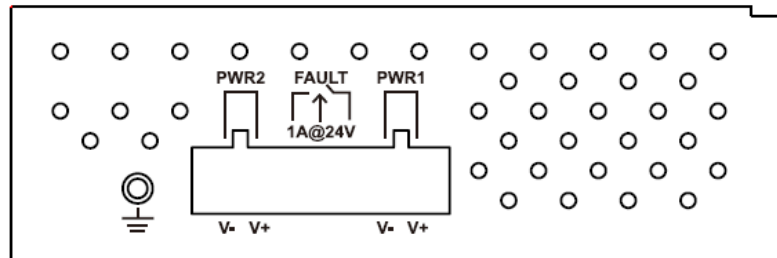
The Front Panel of the **IGC-0101DSFP/IPGC-0101DSFP** is shown as below.



Front Panel of the Industrial Switch Converter

## Top View

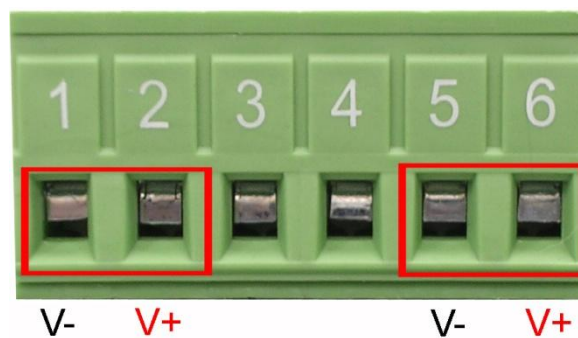
The top panel of the Industrial Switch Converter is equipped one terminal block connector of two DC power inputs.



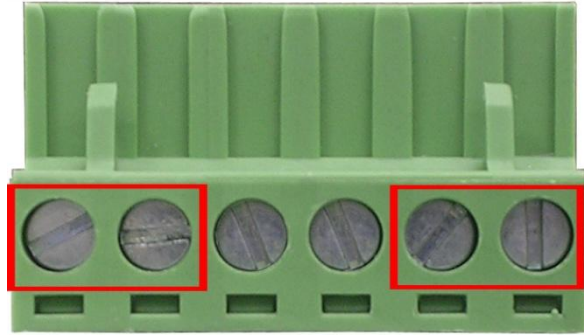
Top panel of the Industrial Switch Converter

## Wiring the Power Inputs

Please follow the steps below to insert the power wire.



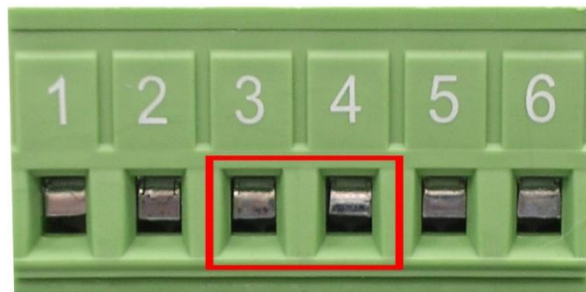
1. Insert the positive and negative wires into the V+ and V- contacts on the terminal block connector.



2. To tighten the wire-clamp screws for preventing the DC wires to loose.

## Wiring the Fault Alarm Contact

The fault alarm contact is in the middle of terminal block connector as the picture shows below. Inserting the wires, it will detect the fault status which the power is failure or port link failure (for managed model) and form an open circuit.



Insert the wires into the fault alarm contact (No. 3 & 4)

---

**Note**      *The wire gauge for the terminal block should be in the range between 12~ 24 AWG.*

---

## LED Indicators

There are few LEDs display the power status and network status located on the front panel of the Industrial switch converter, each of them has its own specific meaning as below table.

<i>Table 2.1: Industrial Switch Converter LED Definition</i>			
LED	Color	Description	
PWR1	Green	On	Power input 1 is active
		Off	Power input 1 is inactive
PWR2	Green	On	Power input 2 is active
		Off	Power input 2 is inactive
Fault	Red	On	Power input 1 or 2 has failed
		Off	Power input 1 and 2 are both functional, or no power input
LNK/ACT (fiber port)	Green	On	Connected to network
		Flashing	Networking is active
		Off	Not connected to network
PoE (IPGC only)	Green	On	Link to PD(PoE device)
		Off	Link to none PoE device

## DIP-Switch

The DIP-Switch is used to configure operation mode for LLF (**Link Lost Forwarding**) and power alarm. The default value of DIP-switch is **OFF**.

<i>Table 2.2: Industrial Switch Converter DIP-Switch Definition</i>		
S/W	Status	Description
Fault	ON	Enable Power Alarm
	OFF	Disable Power Alarm
SFP Speed	100M	Set SFP speed as 100M
	1000M	Set SFP speed as 1000M

## Ports

**RJ-45 ports (Auto MDI/MDIX):** The RJ-45 ports are auto-sensing for 10Base-T, 100Base-TX or 1000Base-T devices connections. Auto MDI/MDIX means that you can connect to another switch or workstation without changing straight through or crossover cabling. See figures as below for straight through and crossover cable schematic.

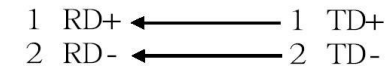
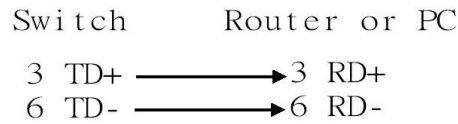
### ■ RJ-45 Pin Assignments

Pin Number	Assignment
1	Tx+
2	Tx-
3	Rx+
6	Rx-

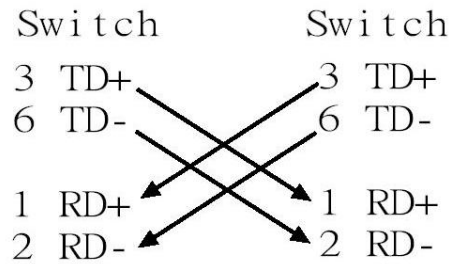
*Note* “+” and “-” signs represent the polarity of the wires that make up each wire pair.

All ports on this industrial switch converter support automatic MDI/MDI-X operation, you can use straight-through cables (See Figure below) for all network connections to PCs or servers, or to other switches or hubs. In straight-through cable, pins 1, 2, 3, and 6, at one end of the cable, are connected straight through to pins 1, 2, 3 and 6 at the other end of the cable. The table below shows the 10BASE-T/100BASE-TX /1000Base-T MDI and MDI-X port pin outs.

Pin MDI-X	Signal Name	MDI Signal Name
1	Receive Data plus (RD+)	Transmit Data plus (TD+)
2	Receive Data minus (RD-)	Transmit Data minus (TD-)
3	Transmit Data plus (TD+)	Receive Data plus (RD+)
6	Transmit Data minus (TD-)	Receive Data minus (RD-)



Straight Through Cable Schematic



Cross Over Cable Schematic

## Cabling

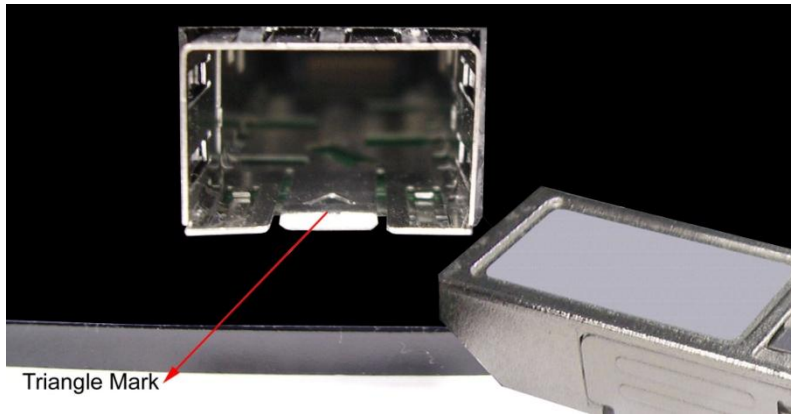
Twisted-pair segment can use unshielded twisted pair (UTP) or shielded twisted pair (STP) cabling. The cable between the link partner (switch, hub, workstation, etc.) and the converter must be less than 100 meters (328 ft.) long and comply with the IEEE 802.3ab 1000Base-T standard for Category 5e or above.

Fiber segment using single-mode connector type must use 9/125 $\mu$ m single-mode fiber cable. You can connect two devices in the distance of 10 km. Fiber segment using multi-mode connector type must use 50/125 or 62.5/125 $\mu$ m multi-mode fiber cable. You can connect two devices up to 550m distances.

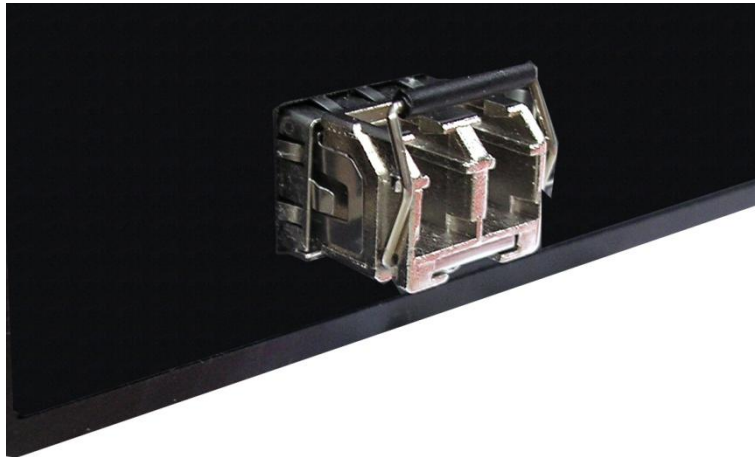
The small form-factor pluggable (SFP) is a compact optical transceiver used in optical communications for both telecommunication and data communication applications.

To connect the transceiver and LC cable, please follow the steps shown below:

First, insert the transceiver into the SFP module. Notice that the triangle mark is the bottom of the module.

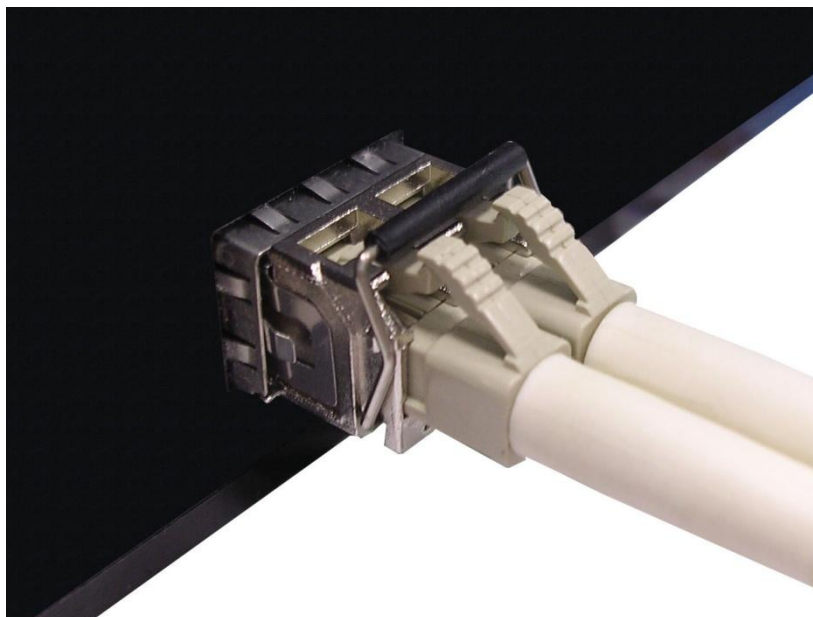


*Figure 2.8: Transceiver to the SFP module*



*Figure 2.9: Transceiver Inserted*

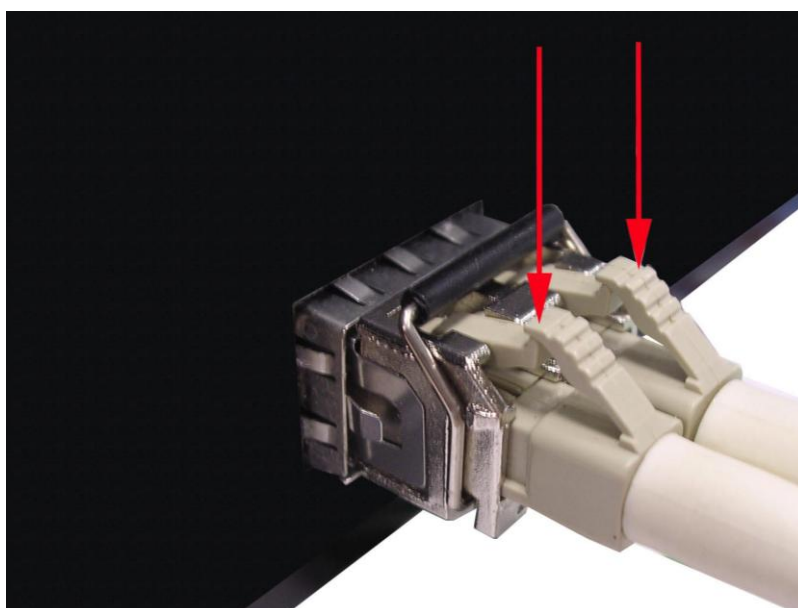
Second, insert the fiber cable of LC connector into the transceiver.



*Figure 2.10: LC connector to the transceiver*

To remove the LC connector from the transceiver, please follow the steps shown below:

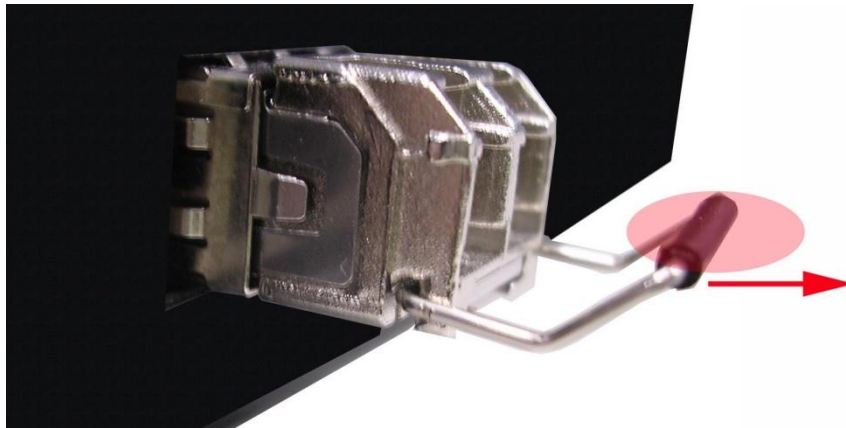
First, press the upper side of the LC connector from the transceiver and pull it out to release.



*Figure 2.11: Remove LC connector*



Second, push down the metal loop and pull the transceiver out by the plastic part.



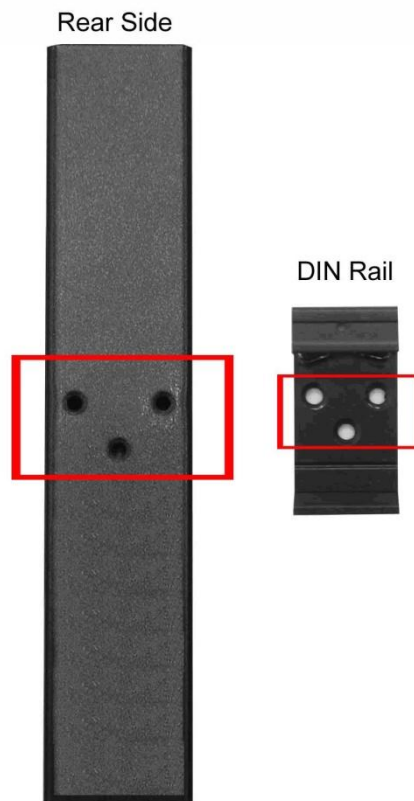
*Figure 2.12: Pull out from the SFP module*

# Mounting Installation

---

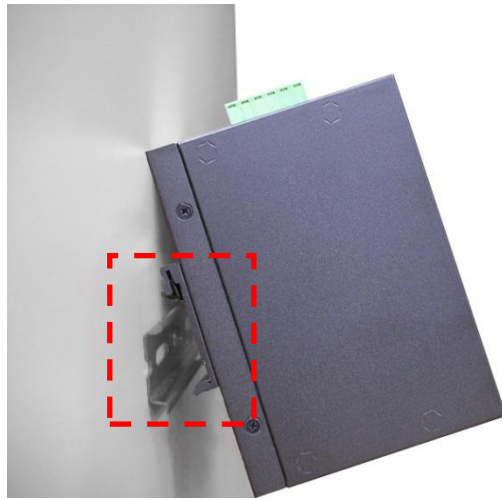
## DIN-Rail Mounting

The DIN-Rail is screwed on the industrial switch when out of factory. If the DIN-Rail is not screwed on the industrial switch, please see the following figure to screw the DIN-Rail on the switch. Follow the below steps to hang the industrial switch.

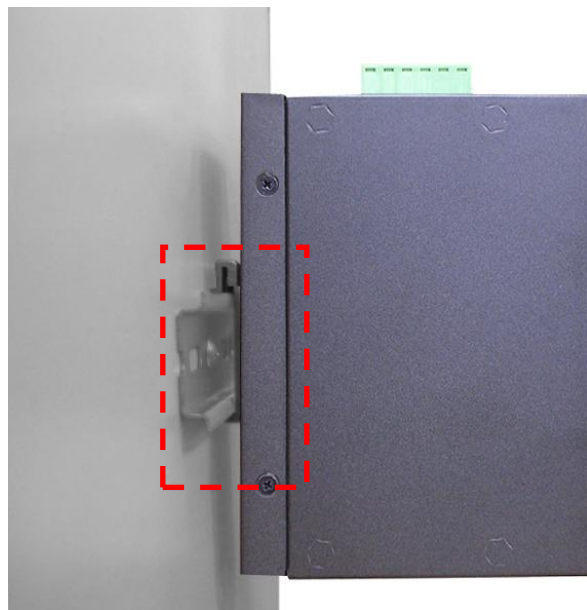


1. Use the screws to screw on the DIN-Rail on the industrial switch
2. To remove the DIN-Rail, reverse the step 1.

3. First, insert the top of DIN-Rail into the track.



4. Then, lightly push the button of DIN-Rail into the track.



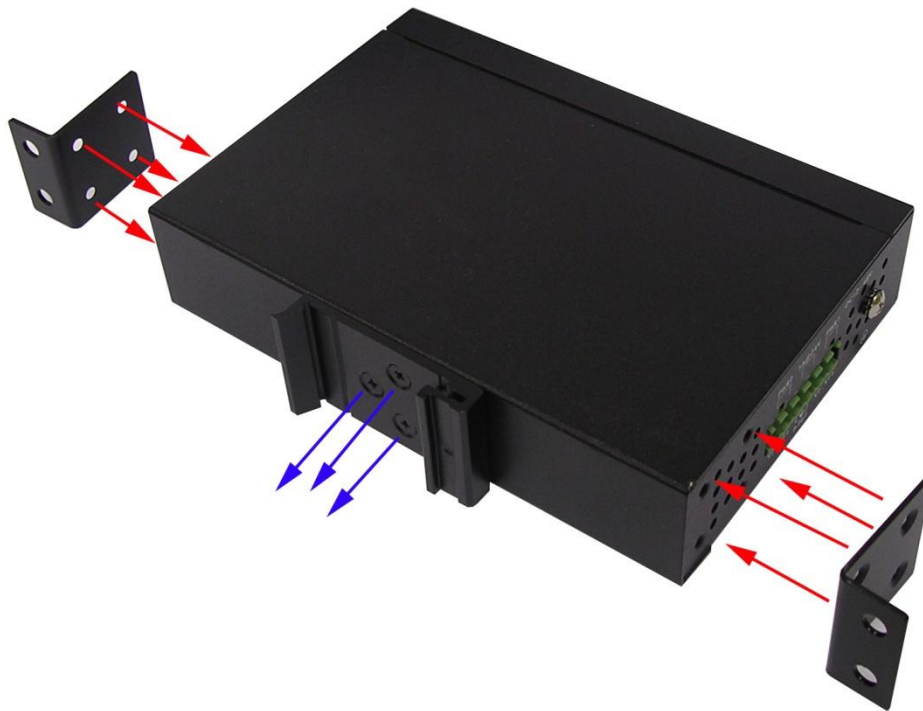
5. Check the DIN-Rail is tightly on the track.
6. To remove the industrial switch from the track, reverse steps above.

## Wall Mount Plate Mounting

**\*Optional Wall Mount Kit required**

Follow the steps below to mount the industrial switch with wall mount plate.

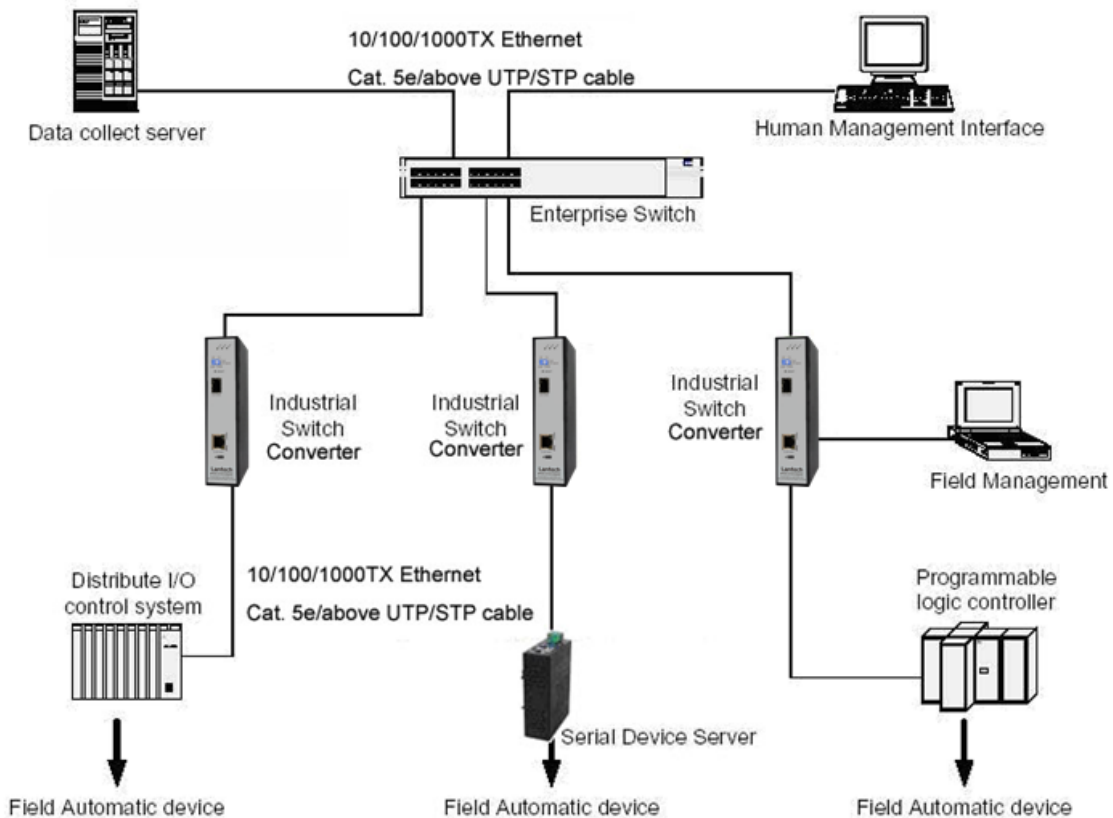
1. Remove the DIN-Rail from the industrial switch; loose the screws to remove the DIN-Rail.
2. Place the wall mount plate on the rear panel of the industrial switch.
3. Use the screws to screw the wall mount plate on the industrial switch.
4. Use the hook holes at the corners of the wall mount plate to hang the industrial switch on the wall.
5. To remove the wall mount plate, reverse steps above.



# Hardware Installation

---

In this paragraph, we will describe how to install the 10/100/1000Base-T Industrial Switch converter and the installation points for the attention.



## Installation Steps

1. Unpacked the Industrial switch converter packing.
2. Check the DIN-Rail is screwed on the Industrial switch converter. If the DIN-Rail is not screwed on the Industrial switch converter. Please refer to **DIN-Rail Mounting** section for DIN-Rail installation. If you want to wall mount the Industrial switch converter, then please refer to **Wall Mount Plate Mounting** section for wall mount plate installation.
3. To hang the Industrial switch converter on the DIN-Rail track or wall, please refer to the **Mounting Installation** section.
4. Power on the Industrial switch converter. How to wire the power; please refer to the **Wiring the Power Inputs** section. The power LED on the

Industrial switch converter will light up. Please refer to the **LED Indicators** section for meaning of LED lights.

5. Prepare the twisted-pair, straight through Category 5 cable for Ethernet connection.
6. Insert one side of Category 5e or above cables into the Industrial switch converter Ethernet port (RJ-45 port) and another side of category 5e or above cables to the network devices' Ethernet port (RJ-45 port), e.g. switch, PC or Server. The UTP port (RJ-45) LED on the Industrial switch converter will light up when the cable connected with the network device. Please refer to the **LED Indicators** section for LED light meaning.

*Note Be sure the connected network devices support MDI/MDI-X. If it does not support, then use the crossover category 5e/above cable.*

7. When all connections are all set and LED lights all show in normal, the installation is complete.

# Troubles shooting

---

- Verify that you are using the right power cord/adaptor (DC 9.5 ~ 56V), please don't use the power adaptor with DC output higher than 56V, or it will burn this switch converter down.
- Select the proper UTP cable to construct your network. Please check that you are using the right cable. Use unshielded twisted-pair (UTP) or shield twisted-pair (STP) cable for RJ-45 connections: 100Ω Category 3, 4 or 5 cable for 10Mbps connections, 100Ω Category 5 cable for 100Mbps, or 100Ω Category 5e/above cable for 1000Mbps connections. Also be sure that the length of any twisted-pair connection does not exceed 100 meters (328 feet).
- **Diagnosing LED Indicators:** To assist in identifying problems, the industrial switch converter can be easily monitored through panel indicators which describe common problems the user may encounter and where the user can find possible solutions.
- IF the power indicator does not light on when the power cord is plugged in, you may have a problem with power cord. Then check for loose power connections, power losses or surges at power outlet. IF you still cannot resolve the problem, contact your local dealer for assistance.
- If the Industrial switch converter LED indicators are normal and the connected cables are correct and the packets still cannot transmit. Please check your system's Ethernet devices' configuration or status.