

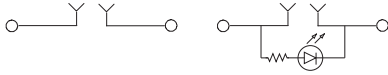

Supplementary Protector / Disconnect Terminal Block Sockets



DN-DIS series Disconnect Terminal Blocks offer the flexibility of opening a circuit without removing any wiring. Available with or without LED indication in 12VDC and 24VDC, they can also be used as a socket for the DN-SUPP series Supplementary Protectors by simply removing the Disconnect Blade.



**DN-DISx Series:
EURO F2.5 / EURO F4**

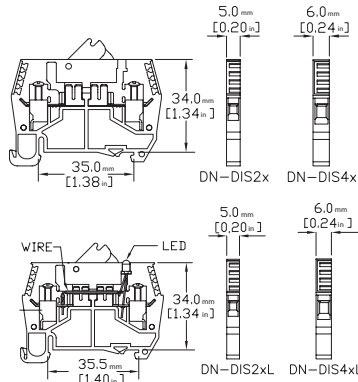

**DN-DISxL Series: EURO F2
with LED / EURO F4 with LED**

Ordering Information

	Part Number	Trip Indicator	Pcs/ Pkg	Price	Part Number	Trip Indicator	Pcs/ Pkg	Price
Gray Socket with Disconnect	<i>DN-DIS2</i>	—	50	\$75.00	<i>DN-DIS4</i>	—	50	\$75.00
	<i>DN-DIS2MN</i>	—	10	\$18.25	<i>DN-DIS4MN</i>	—	10	\$18.25
	<i>DN-DIS2L12</i>	12 VAC/DC LED	50	\$77.00	<i>DN-DIS4L12</i>	12 VAC/DC LED	50	\$77.00
	<i>DN-DIS2L12MN</i>	12 VAC/DC LED	10	\$21.75	<i>DN-DIS4L12MN</i>	12 VAC/DC LED	10	\$21.75
	<i>DN-DIS2L24</i>	24 VAC/DC LED	50	\$77.00	<i>DN-DIS4L24</i>	24 VAC/DC LED	50	\$77.00
	<i>DN-DIS2L24MN</i>	24 VAC/DC LED	10	\$21.75	<i>DN-DIS4L24MN</i>	24 VAC/DC LED	10	\$21.75

Technical Specifications

Stripping Length	5mm [0.20 in]			6mm [0.24 in]		
Tightening Torque	0.5 N·m [4.4 lb·in]			0.8 N·m [7 lb·in]		
UL Approval*	300V	10A with SUPP 20A with disconnect	24-12 AWG*	300V	10A with SUPP 25A with disconnect	24-10 AWG*
Operating Temperature	Ambient air temperature: -20°C to 85°C [-4°F to 185°F] Relative humidity: 50% max at 40°C [104°F]; 90% max at 20°C [68°F]					
SCCR Rating	10kA per Table SB4.1, 2009, UL 508A, Maximum short circuit current rating for unmarked components					
CE Conformity	CE (EN 60947-1 / 60947-7-3)					
Agency File #	UL E179129					

Note: To obtain the most current agency approval information, see the Agency Approval Checklist section on the specific part number's web page.

Accessories

End Cover/ Spacer**	<i>DN-FESPA</i>	50	\$15.00	<i>DN-FESPA</i>	50	\$15.00	
	<i>DN-FESPA-10</i>	10	\$3.00	<i>DN-FESPA-10</i>	10	\$3.00	
Separator	<i>DN-FESEP</i>	50	\$15.00	<i>DN-FESEP</i>	50	\$15.00	
	<i>DN-FESEP-10</i>	10	\$3.00	<i>DN-FESEP-10</i>	10	\$3.00	
35mm DIN Rail	7.5 mm high	<i>DN-R35S1</i>	10	\$28.00	<i>DN-R35S1</i>	10	\$28.00
		<i>DN-R35S1-2</i>	2	\$9.00	<i>DN-R35S1-2</i>	2	\$9.00
	15mm high	<i>DN-R35HS1</i>	10	\$49.50	<i>DN-R35HS1</i>	10	\$49.50
		<i>DN-R35HS1-2</i>	2	\$12.00	<i>DN-R35HS1-2</i>	2	\$12.00
End Brackets	<i>DN-EB35</i>	50	\$39.50	<i>DN-EB35</i>	50	\$39.50	
	<i>DN-EB35MN</i>	20	\$18.00	<i>DN-EB35MN</i>	20	\$18.00	
	<i>DN-EB35-A</i>	50	\$28.50	<i>DN-EB35-A</i>	50	\$28.50	
	<i>DN-EB35-A-10</i>	10	\$7.50	<i>DN-EB35-A-10</i>	10	\$7.50	
	<i>DN-QEB35</i>	50	\$25.50	<i>DN-QEB35</i>	50	\$25.50	
	<i>DN-QEB35-10</i>	10	\$7.50	<i>DN-QEB35-10</i>	10	\$7.50	
Angled Support Bracket	<i>DN-ASB1</i>	50	\$49.50	<i>DN-ASB1</i>	50	\$49.50	
Disconnect Blade	<i>DN-DIS-BLADE</i>	50	\$21.50	<i>DN-DIS-BLADE</i>	50	\$21.50	
	<i>DN-DIS-BMN</i>	10	\$5.50	<i>DN-DIS-BMN</i>	10	\$5.50	
Marking Tags	<i>DN-LA or DN-LT series</i>	500/ 100	various	<i>DN-L or DN-LT series</i>	500/ 100	various	

*For copper wire only

**Use one End Cover / Spacer per DN-FEx Terminal Block Socket when using DN-SUPP-x supplementary protector

Note: For more information on accessories, see the DINnectors Accessories section of this chapter.

DINnectors™

Terminal Block Sockets

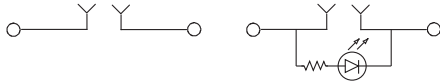

F2.5/
F4 SP socket
block

F2.5/
F4 SP socket
block w/LED



DN-FEx Series:
EURO F2.5 / EURO F4



**DN-FExL Series: EURO F2
with LED / EURO F4 with LED**

DN-FE series terminal block sockets accept separately available circuit disconnects or supplementary protectors. The DN-FE blocks are available either with or without a trip-indicating LED and they are 35mm DIN-rail mountable. The LED blocks are polarity-sensitive, with the LED side negative.

Ordering Information

	Part Number	Trip Indicator	Pcs/Pkg	Price	Part Number	Trip Indicator	Pcs/Pkg	Price
Socket Only	DN-FE2	—	50	\$65.00	DN-FE4	—	50	\$65.00
	DN-FE2-5	—	5	\$7.00	DN-FE4-5	—	5	\$7.00
	DN-FE2L12	12 VAC/DC LED	50	\$89.00	DN-FE4L12	12 VAC/DC LED	50	\$89.00
	DN-FE2L12-5	12 VAC/DC LED	5	\$9.00	DN-FE4L12-5	12 VAC/DC LED	5	\$9.00
	DN-FE2L24	24 VAC/DC LED	50	\$89.00	DN-FE4L24	24 VAC/DC LED	50	\$89.00
	DN-FE2L24-5	24 VAC/DC LED	5	\$9.00	DN-FE4L24-5	24 VAC/DC LED	5	\$9.00

Technical Specifications

Stripping Length	5mm [0.24 in]				6mm [0.24 in]			
Tightening Torque	0.5 N·m [4.4 lb·in]				0.8 N·m [7 lb·in]			
UL Approval*	300V	10A with SUPP 20A with disconnect	24-12 AWG*		300V	10A with SUPP 25A with disconnect	24-10 AWG*	
Operating Temperature	Ambient air temperature: -20°C to 105°C [-4°F to 221°F] / Relative humidity: 50% max at 40°C [104°F]; 90% max at 20°C [68°F]							
SCCR Rating	10kA per Table SB4.1, 2009, UL 508A, Maximum short circuit current rating for unmarked components							
CE Conformity	CE (EN 60947-1 / EN 60947-7-3)							
Agency File #	UL E179129							

Note: To obtain the most current agency approval information, see the Agency Approval Checklist section on the specific part number's web page.

Accessories

End Cover/Spacer**	DN-FESPA	50	\$15.00	DN-FESPA	50	\$15.00
	DN-FESPA-10	10	\$3.00	DN-FESPA-10	10	\$3.00
Separator	DN-FESEP	50	\$15.00	DN-FESEP	50	\$15.00
	DN-FESEP-10	10	\$3.00	DN-FESEP-10	10	\$3.00
Jumper	12-pole DN-12JFE	10	\$35.00	DN-12JFE	10	\$35.00
Jumper Cutting Tool	DN-JFECUT	1	\$55.00	DN-JFECUT	1	\$55.00
35mm DIN Rail	7.5 mm high DN-R35S1	10	\$28.00	DN-R35S1	10	\$28.00
	DN-R35S1-2	2	\$9.00	DN-R35S1-2	2	\$9.00
	15mm high DN-R35HS1	10	\$49.50	DN-R35HS1	10	\$49.50
	DN-R35HS1-2	2	\$12.00	DN-R35HS1-2	2	\$12.00
End Brackets	DN-EB35	50	\$39.50	DN-EB35	50	\$39.50
	DN-EB35MN	20	\$18.00	DN-EB35MN	20	\$18.00
	DN-EB35-A	50	\$28.50	DN-EB35-A	50	\$28.50
	DN-EB35-A-10	10	\$7.50	DN-EB35-A-10	10	\$7.50
	DN-QEB35	50	\$25.50	DN-QEB35	50	\$25.50
	DN-QEB35-10	10	\$7.50	DN-QEB35-10	10	\$7.50
Angled Support Bracket	DN-ASB1	50	\$49.50	DN-ASB1	50	\$49.50
Disconnect Blade	DN-DIS-BLADE	50	\$21.50	DN-DIS-BLADE	50	\$21.50
	DN-DIS-BMN	10	\$5.50	DN-DIS-BMN	10	\$5.50
Supplementary Protector	DN-SUPP-x***	see next page		DN-SUPP-x***	see next page	
Marking Tags	DN-LA or DN-LT series	500/100	various	DN-L or DN-LT series	500/100	various

*For copper wire only

**Use one End Cover / Spacer per DN-FEx Terminal Block Socket when using DN-SUPP-x supplementary protector

***Trip ratings available from 0.25 A to 10A

Note: For more information on accessories, see the DINnectors Accessories section of this chapter.

DN-FEx with DN-SUPP-x Supplementary Protector

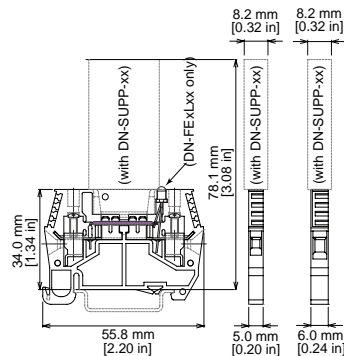

DN-FE2, DN-FE2Lxx
DN-FE4, DN-FE4Lxx
DN-FE2xxx DN-FE4xxx

DN-DIS-xxx dimensions are the same as DN-FExxx dimensions.

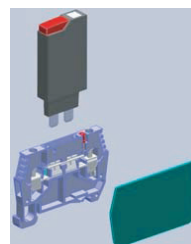

When aligned alone, use DN-FESEP

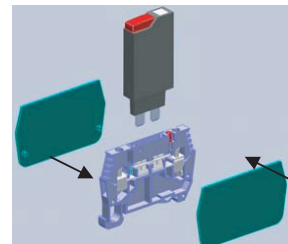

When aligned in a row, use 2pcs DN-FESPA for DN-FE2
2pcs DN-FESEP for DN-FE4



Supplementary Protectors for Terminal Block Sockets

Supplementary Protectors							
Part Number	Reference	Rated Current	Internal Resistance	Type	Fits Socket	Pcs /Pkg	Price /Pkg
DN-SUPP-P25	435T0025	0.25 A	14Ω	UL1077 Single Pole Push On Push Off Push to Reset	Terminal Block Socket Types: DN-FEx or DN-DISx if disconnect blade is removed	20	\$197.00
DN-SUPP-P25-1						1	\$10.00
DN-SUPP-P5	435T0050	0.5 A	3.4 Ω			20	\$197.00
DN-SUPP-P5-1						1	\$10.00
DN-SUPP-1	435T0100	1A	0.9 Ω			20	\$197.00
DN-SUPP-1-1						1	\$10.00
DN-SUPP-2	435T0200	2A	0.25 Ω			20	\$197.00
DN-SUPP-2-1						1	\$10.00
DN-SUPP-3	435T0300	3A	0.11 Ω			20	\$197.00
DN-SUPP-3-1						1	\$10.00
DN-SUPP-4	435T0400	4A	0.07 Ω			20	\$197.00
DN-SUPP-4-1						1	\$10.00
DN-SUPP-6	435T0600	6A				20	\$197.00
DN-SUPP-6-1						1	\$10.00
DN-SUPP-8	435T0800	8A	≤0.05 Ω			20	\$197.00
DN-SUPP-8-1						1	\$10.00
DN-SUPP-10	435T1000	10A		20	\$197.00		
DN-SUPP-10-1				1	\$10.00		



DN-SUPP-x
Supplementary Protector
(plugs into DN-FE EURO F series socket)

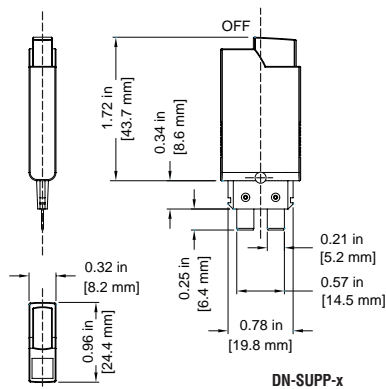

Supplementary Protector Specifications DN-SUPP-x Series	
Voltage Rating (UL – U.S. & Canada)	250VAC / 72VDC
Voltage Rating (VDE)	250VAC / 65VDC
Typical Life Span	6,000 operations @ 1 x IN (low inductance) 3,000 operations @ 1 x IN (inductive) 500 operations @ 2 x IN (inductive)
Insulation Coordination (IEC 60664 & 60664A)	Rated impulse withstand voltage 2.5 kV; reinforced insulation in operating area; pollution degree 2
Dielectric Strength (IEC 60664 & 60664A)	Operating area: 3,000VAC Installation area: 1,500VAC
Insulation Resistance	>100MΩ @ 500VDC
Interrupting Capacity (UL 1077), SCCR	2,000A @ 250VAC; 200A @ 65VDC, SCCR = 2kA with series overcurrent protection
Interrupting Capacity ICN	0.1 to 5A: 6 x IN 6 to 10A: 8 x IN
Degree of Protection (IEC 60529 / DIN 40050)	Operating area IP40; terminal area IP00
Vibration (without terminal block)	5g (57-500 Hz) ±0.38 mm (10-57 Hz) to IEC 60068-2-6, test Fc, 10 frequency cycles/axis and to EN 50155
Shock (without terminal block)	25g (11ms) to IEC 60068-2-27, test Ea
Corrosion	96 hours @ 5% salt mist to IEC 60068-2-11, test Ka
Usage Temperature	-4°F to 140°F (-20°C to 60°C)
Humidity	240 hours @ 95% RH to IEC 60068-2-3, test Ca
Mass (weight)	15g (0.53 oz)
Agency Approval	UL file # E320462 (435T Series); VDE
Mounting Restrictions	When 2 or more devices are mounted side by side, each device should only carry 80% of its rating, or must be derated accordingly.

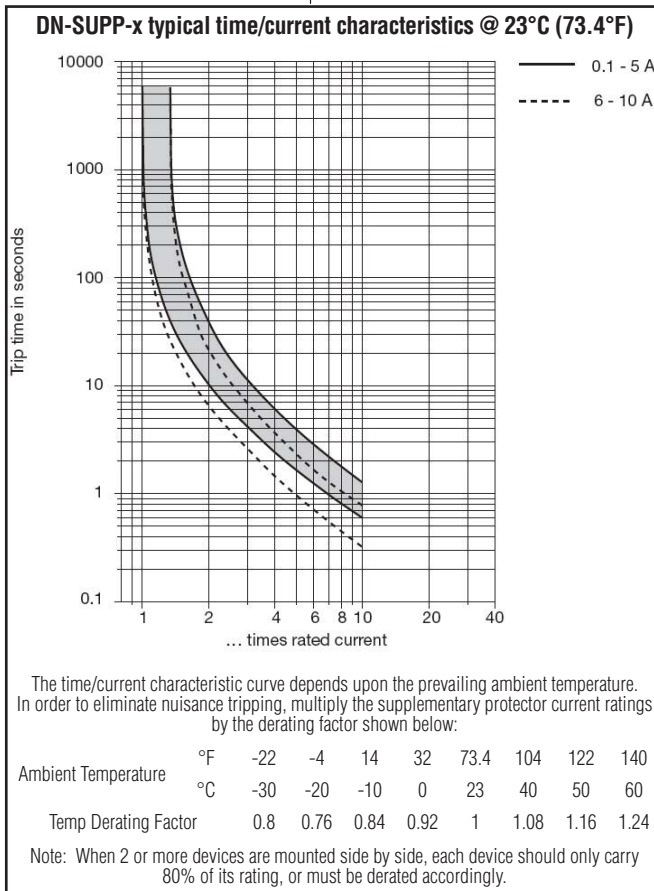

DINnectors™ Accessories

DN-LB (blank) shown on left



DN-L

- Fits terminal block types:** All except, Screwless DINnectors, DN-T12-A, DN-M10-A, DN-MG, and DN-TL series
- Material:** Thermoplastic with heat embossed black print

Note:

- The marking sequence of 50 tags (i.e. 101-150) is printed 10 times in each package of 500 tags.
- The DN-L tags fit all DINnectors 6mm wide and wider.
- The DN-L tags fit all DINnectors 6mm wide and wider but will leave a gap between tags on blocks wider than 6mm.

Dimensions

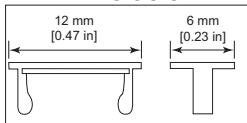

Marking Sequence	Part#	Pcs/Pkg	Price
1-50	DN-L50	500	\$32.50
51-100	DN-L100	500	\$32.50
101-150	DN-L150	500	\$32.50
151-200	DN-L200	500	\$32.50
201-250	DN-L250	500	\$32.50
251-300	DN-L300	500	\$32.50
301-350	DN-L350	500	\$32.50
351-400	DN-L400	500	\$32.50
401-450	DN-L450	500	\$32.50
Blank	DN-LB	500	\$22.00
L1, L2, L3, L, N, GND, +, -, COM, COM*	DN-LS	500	\$32.50

DN-QL

- Fits terminal block types:** Screwless DN-Q series
- Material:** Thermoplastic with heat embossed black print. Packaged 100 labels per card, and five cards per box.

Note:

- The marking sequence (i.e. 1-100) is printed five times in each package of 500 tags.

Dimensions

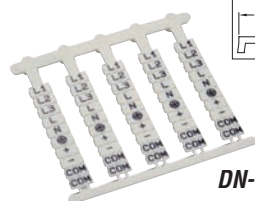
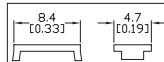

DN-QLS Shown

Marking Sequence	Part #	Pcs/Pkg	Price
1-100	DN-QL100	500	\$25.50
101-200	DN-QL200	500	\$25.50
201-300	DN-QL300	500	\$25.50
301-400	DN-QL400	500	\$25.50
401-500	DN-QL500	500	\$25.50
Blank Tags	DN-QLB	500	\$21.50
L1, L2, L3, L, N, ⊕, +, -, COM, COM*	DN-QLS	500	\$29.00

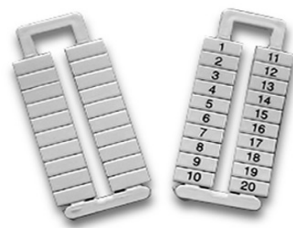

DN-LAB (blank) shown on right; part of DN-LA100 on left

DN-LA

- Fits terminal block types:** DN-T12-A series
- Material:** Thermoplastic with heat embossed black print

Note:

- The marking sequence (i.e. 1-100) is printed five times in each package of 500 tags.
- The DN-T12-A series is 5mm wide, so the 6mm wide DN-L tags do not fit these blocks.
- The DN-LA tags fit all DINnectors 5mm wide and wider but will leave a gap between tags on blocks wider than 5mm.

Dimensions

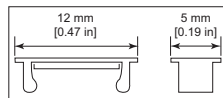

Marking Sequence	Part#	Pcs/Pkg	Price
1-100	DN-LA100	500	\$32.50
101-200	DN-LA200	500	\$32.50
201-300	DN-LA300	500	\$32.50
301-400	DN-LA400	500	\$32.50
Blank Tags	DN-LAB	500	\$32.50
L1, L2, L3, L, N, GND, +, -, COM, COM*	DN-LAS	500	\$32.50

DN-LAT-A

- Fits terminal block types:** Triple level DN-TL14
- Material:** Thermoplastic with heat embossed black print

Note:

- The marking sequence (i.e. 1-100) is printed five times in each package of 500 tags.

Dimensions

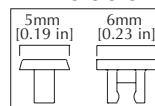

Marking Sequence	Part #	Pcs/Pkg	Price
1-100	DN-LAT100-A	500	\$29.00
101-200	DN-LAT200-A	500	\$29.00
201-300	DN-LAT300-A	500	\$29.00
301-400	DN-LAT400-A	500	\$29.00
401-500	DN-LAT500-A	500	\$29.00
501-600	DN-LAT600-A	500	\$29.00
Blank Tags	DN-LATB-A	500	\$21.00
L1, L2, L3, L, N, ⊕, +, -, COM, COM*	DN-LATS-A	500	\$29.00



DN-LTA marker shown top; DN-LT60 marker shown middle; DN-LTGND shown bottom

DN-LT

- Fits terminal block types:** All except Screwless DINnectors (see DN-QL series)
- Material:** Thermoplastic with heat embossed black print

Note:

- These marking tags allow the flexibility of creating custom marking sequences on site.
- The DN-M10-A support a maximum of three digits (tags), while other DINnectors support up to four digits (tags)

Dimensions

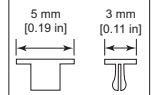

Marking Sequence	Part#	Pcs/Pkg	Price
1-5	DN-LT15	100	\$5.75
6-0	DN-LT60	100	\$5.75
1	DN-LT1	100	\$5.75
2	DN-LT2	100	\$5.75
3	DN-LT3	100	\$5.75
4	DN-LT4	100	\$5.75
5	DN-LT5	100	\$5.75
6	DN-LT6	100	\$5.75
7	DN-LT7	100	\$5.75
8	DN-LT8	100	\$5.75
9	DN-LT9	100	\$5.75
0	DN-LT0	100	\$5.75
Unprinted	DN-LTBLNK	100	\$5.75
A	DN-LTA	100	\$5.75
B	DN-LTB	100	\$5.75
C	DN-LTC	100	\$5.75
D	DN-LTD	100	\$5.75
E	DN-LTE	100	\$5.75
F	DN-LTF	100	\$5.75
G	DN-LTG	100	\$5.75
H	DN-LTH	100	\$5.75
I	DN-LTI	100	\$5.75
J	DN-LTJ	100	\$5.75
K	DN-LTK	100	\$5.75
L	DN-LTL	100	\$5.75
M	DN-LTM	100	\$5.75
N	DN-LTN	100	\$5.75
-	-	-	-
P	DN-LTP	100	\$5.75
Q	DN-LTQ	100	\$5.75
R	DN-LTR	100	\$5.75
S	DN-LTS	100	\$5.75
T	DN-LTT	100	\$5.75
U	DN-LTU	100	\$5.75
V	DN-LTV	100	\$5.75
W	DN-LTW	100	\$5.75
X	DN-LTX	100	\$5.75
Y	DN-LTY	100	\$5.75
Z	DN-LTZ	100	\$5.75
⊕	DN-LTGND	100	\$5.75
+	DN-LTPOS	100	\$5.75
-	DN-LTNEG	100	\$5.75
~	DN-LTAC	100	\$5.75
=	DN-LTDC	100	\$5.75

DINnectors™ Accessories

Terminal Marking Accessories



DN-EMLBL1



DN-EMLBL2



DN-EMLBL3

Part #	Description	For Use With	Pcs/Pkg	Price Each
DN-EMLBL1	Blank labels	DN-EMPEG1 pin protectors for DN-xEMXxx plug-in terminal blocks	100	\$5.25
DN-EMLBL2	Labels printed 1 – 12		100	\$7.25
DN-EMLBL3	Labels printed 13 – 24		100	\$7.25



DN-MTA marking tag adapter

DN-MTA dimensions

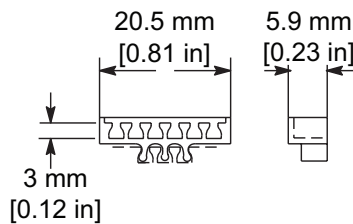

Part#	Description	Pcs/Pkg	Price Each
DN-MTA	Marking tag adapter holds up to six DN-LT tags	50	\$8.00

Note: DN-MTA adapter does not fit DN-T12-A terminal blocks.

Marking Pen – for terminal and wire marking tags

- Permanent
- Smudge-proof
- Waterproof
- Weatherproof
- Lightfast (won't fade)
- Dries in seconds (excellent for left-handed users)
- Dry-safe (pen can be left uncapped for days without drying out)
- Low odor ink

Part#	Description	Pcs/Pkg	Price Each
DN-MP	Indelible black ink marking pen	1	\$3.75



Marking pen

Wire Marking Accessories



DN-WMTAG1 wire tags & DN-WM-x wire tag holders

Part #	Description	For Use With	Pcs/Pkg	Price Each
DN-WMTAG1	Wire tag – blank	all DN-WM-x wire tag holders	525	\$34.50
DN-WM-1	Wire tag holder, clear, 12mm length, 0.051–0.118 in diameter; for 22–16 AWG wire	DN-WMTAG1	200	\$7.00
DN-WM-2	Wire tag holder, clear, 12mm length, 0.098–0.196 in diameter; for 16–11 AWG wire		200	\$7.00
DN-WM-3	Wire tag holder, clear, 12mm length, 0.157–0.393 in diameter; for 13–5 AWG wire		100	\$4.75
DN-WM-4	Wire tag holder, clear, 12mm length, 0.314–0.629 in diameter; for 5AWG wire		100	\$4.25