

SIEMENS

RUGGEDCOM RS900L

Installation Guide

Preface

Introduction

1

Installing the Device

2

Communication Ports

3

Technical Specifications

4

Dimension Drawings

5

Certification

6

Copyright © 2013 Siemens AG

All rights reserved. Dissemination or reproduction of this document, or evaluation and communication of its contents, is not authorized except where expressly permitted. Violations are liable for damages. All rights reserved, particularly for the purposes of patent application or trademark registration.

This document contains proprietary information, which is protected by copyright. All rights are reserved. No part of this document may be photocopied, reproduced or translated to another language without the prior written consent of Siemens AG.

Disclaimer Of Liability

Siemens has verified the contents of this manual against the hardware and/or software described. However, deviations between the product and the documentation may exist.

Siemens shall not be liable for any errors or omissions contained herein or for consequential damages in connection with the furnishing, performance, or use of this material.

The information given in this document is reviewed regularly and any necessary corrections will be included in subsequent editions. We appreciate any suggested improvements. We reserve the right to make technical improvements without notice.

Registered Trademarks

ROX™, Rugged Operating System On Linux™, CrossBow™ and eLAN™ are trademarks of Siemens AG. ROS® is a registered trademark of Siemens AG.

Other designations in this manual might be trademarks whose use by third parties for their own purposes would infringe the rights of the owner.

Third Party Copyrights

Siemens recognizes the following third party copyrights:

- Copyright © 2004 GoAhead Software, Inc. All Rights Reserved.

Security Information

Siemens provides products and solutions with industrial security functions that support the secure operation of plants, machines, equipment and/or networks. They are important components in a holistic industrial security concept. With this in mind, Siemens' products and solutions undergo continuous development. Siemens recommends strongly that you regularly check for product updates.

For the secure operation of Siemens products and solutions, it is necessary to take suitable preventive action (e.g. cell protection concept) and integrate each component into a holistic, state-of-the-art industrial security concept. Third-party products that may be in use should also be considered. For more information about industrial security, visit <http://www.siemens.com/industrialsecurity>.

To stay informed about product updates as they occur, sign up for a product-specific newsletter. For more information, visit <http://support.automation.siemens.com>.

Warranty

Siemens warrants this product for a period of five (5) years from the date of purchase, conditional upon the return to factory for maintenance during the warranty term. This product contains no user-serviceable parts. Attempted service by unauthorized personnel shall render all warranties null and void. The warranties set forth in this article are exclusive and are in lieu of all other warranties, performance guarantees and conditions whether written or oral, statutory, express or implied (including all warranties and conditions of merchantability and fitness for a particular purpose, and all warranties and conditions arising from course of dealing or usage or trade). Correction of nonconformities in the manner and for the period of time provided above shall constitute the Seller's sole liability and the Customer's exclusive remedy for defective or nonconforming goods or services whether claims of the Customer are based in contract (including fundamental breach), in tort (including negligence and strict liability) or otherwise.

For warranty details, visit www.siemens.com/ruggedcom or contact a Siemens customer service representative.

Contacting Siemens

Address

Siemens AG
Industry Sector
300 Applewood Crescent
Concord, Ontario
Canada, L4K 5C7

Telephone

Toll-free: 1 888 264 0006
Tel: +1 905 856 5288
Fax: +1 905 856 1995

E-mail

ruggedcom.info.i-ia@siemens.com

Web

www.siemens.com/ruggedcom

Table of Contents

Preface	v
Alerts	v
Related Documents	v
Accessing Documentation	v
Training	vi
Customer Support	vi
 Chapter 1	
Introduction	1
1.1 Feature Highlights	1
1.2 Ports, Controls and Indicator LEDs	2
 Chapter 2	
Installing the Device	5
2.1 Mounting the Device	5
2.1.1 Mounting the Device on a DIN Rail	6
2.1.2 Mounting the Device to a Panel	6
2.2 Connecting Power	7
2.2.1 Connecting High AC/DC Power	8
2.2.2 Connecting Low DC Power	9
2.3 Connecting the Failsafe Alarm Relay	10
2.4 Connecting to the Device	11
2.5 Cabling Recommendations	12
 Chapter 3	
Communication Ports	13
3.1 Copper Ethernet Ports	13
3.2 Fiber Optic Ethernet Ports	14
3.3 EoVDSL Ports	15
3.3.1 EoVDSL Wiring	16
3.3.2 Configuration and Setup	17
3.3.3 EoVDSL Performance	17
 Chapter 4	
Technical Specifications	19
4.1 Power Supply Specifications	19

4.2 Failsafe Relay Specifications	19
4.3 Copper Ethernet Port Specifications	20
4.4 Fiber Optic Ethernet Port Specifications	20
4.5 Operating Environment	21
4.6 Mechanical Specifications	21
Chapter 5	
Dimension Drawings	23
Chapter 6	
Certification	25
6.1 Agency Approvals	25
6.2 FCC Compliance	25
6.3 Industry Canada Compliance	25
6.4 EMI and Environmental Type Tests	26

Preface

This guide describes the RUGGEDCOM RS900L. It describes the major features of the device, installation, commissioning and important technical specifications.

It is intended for use by network technical support personnel who are responsible for the installation, commissioning and maintenance of the device. It is also recommended for use by network and system planners, system programmers, and line technicians.

Alerts

The following types of alerts are used when necessary to highlight important information.



DANGER!

DANGER alerts describe imminently hazardous situations that, if not avoided, will result in death or serious injury.



WARNING!

WARNING alerts describe hazardous situations that, if not avoided, may result in serious injury and/or equipment damage.



CAUTION!

CAUTION alerts describe hazardous situations that, if not avoided, may result in equipment damage.



IMPORTANT!

IMPORTANT alerts provide important information that should be known before performing a procedure or step, or using a feature.



NOTE

NOTE alerts provide additional information, such as facts, tips and details.

Related Documents

Other documents that may be of interest include:

- *ROS User Guide for RS900LW/RS930LW*

Accessing Documentation

The latest Hardware Installation Guides and Software User Guides for most RUGGEDCOM products are available online at www.siemens.com/ruggedcom.

For any questions about the documentation or for assistance finding a specific document, contact a Siemens sales representative.

Training

Siemens offers a wide range of educational services ranging from in-house training of standard courses on networking, Ethernet switches and routers, to on-site customized courses tailored to the customer's needs, experience and application.

Siemens' Educational Services team thrives on providing our customers with the essential practical skills to make sure users have the right knowledge and expertise to understand the various technologies associated with critical communications network infrastructure technologies.

Siemens' unique mix of IT/Telecommunications expertise combined with domain knowledge in the utility, transportation and industrial markets, allows Siemens to provide training specific to the customer's application.

For more information about training services and course availability, visit www.siemens.com/ruggedcom or contact a Siemens sales representative.

Customer Support

Customer support is available 24 hours, 7 days a week for all Siemens customers. For technical support or general information, please contact Customer Support at:

Toll Free (North America): 1 866 922 7975

International: +1 905 856 5288

Website: <http://support.automation.siemens.com>

1 Introduction

The RUGGEDCOM RS900L is an eight-port industrially hardened, fully managed Ethernet switch supporting Ethernet over VDSL (EoVDSL) allowing up to 5km LAN segments over telephone grade cable at up to 35 Mbps. The RS900L has one EoVDSL port allowing for aggregation of Ethernet enabled devices at remote locations back to the central control room. It is the perfect solution for bringing Ethernet networking to applications where telephone wiring is already present thus saving the considerable cost of installing new network cabling.

Designed to operate reliably in harsh industrial environments the RS900L provides a high level of immunity to electromagnetic interference and heavy electrical surges typical of environments found in electric utility substations, factory floors or in curb-side traffic control cabinets. An operating temperature range of -40 to 85 °C (-40 to 185 °F) coupled with hazardous location certification, optional conformal coating and a galvanized steel enclosure allows the RS900L to be placed in almost any location.

The RS900L is packaged in a compact, galvanized steel enclosure that allows either DIN or panel mounting for efficient use of cabinet space. The RS900L provides an integrated power supply with a wide range of voltages (88-300 VDC or 85-264 VAC) for worldwide operability or dual-redundant, reversible polarity, 12 VDC, 24 VDC and 48 VDC power supply inputs for high availability applications requiring dual or backup power inputs.

The following sections provide more information about the RS900L:

- [Section 1.1, “Feature Highlights”](#)
- [Section 1.2, “Ports, Controls and Indicator LEDs”](#)

Section 1.1

Feature Highlights

Ethernet Ports

- One Ethernet over VDSL (EoVDSL) interface
- Six fast Ethernet ports (10/100Base-TX)
- Optional: additional two fast Ethernet ports (10/100Base-TX or 100Base-FX)

Cyber Security

- Multi-level user passwords
- SSH/SSL (128-bit encryption)
- Enable/disable ports, MAC based port security
- Port based network access control (802.1x)
- VLAN (802.1Q) to segregate and secure network traffic
- RADIUS centralized password management
- SNMPv3 authentication and 56-bit encryption

Ethernet Over VDSL (EoVDSL)

- Up to 5 km (3 mi) LAN segments
- Symmetric data rates up to 35 Mbps

- Asymmetric data rates up to 40 Mbps
- Automatically selects fastest data rate based on distance and quality of cable
- Software selectable to be master or slave
- Frequency Division Multiplexing (FDM)

Rated for Reliability in Harsh Environments

- Immunity to EMI and heavy electrical surges
 - Meets IEEE 1613 class 1 (electric utility substations)
 - Exceeds IEC 61850-3 (electric utility substations)
 - Exceeds IEC 61800-3 (variable speed drive systems)
 - Exceeds IEC 61000-6-2 (generic industrial)
 - Exceeds NEMA TS-2 (traffic control equipment)
- Hazardous Location Certification: Class 1 Division 2
- -40 to 85 °C (-40 to 185 °F) operating temperature (no fans)
- 20 AWG galvanized steel enclosure
- DIN or panel mounting options provide secure mechanical reliability
- Conformal coated printed circuit boards (optional)

Management Tools

- Web-based, Telnet, CLI management interfaces
- SNMP v1/v2/v3 (56-bit encryption)
- Remote Monitoring (RMON)
- Rich set of diagnostics with logging and alarms

Universal Power Supply Options

- Fully integrated power supply
- Universal high-voltage range: 88-300 VDC or 85-264 VAC
- Dual low-voltage DC inputs: 24 VDC (10-36 VDC) or 48 VDC (36-72 VDC)
- Terminal blocks for reliable maintenance free connections
- CSA/UL 60950-1 safety approved to 85 °C (185 °F)

Section 1.2

Ports, Controls and Indicator LEDs

The RS900L features various ports, controls and indicator LEDs on the front panel for configuring and troubleshooting the device.

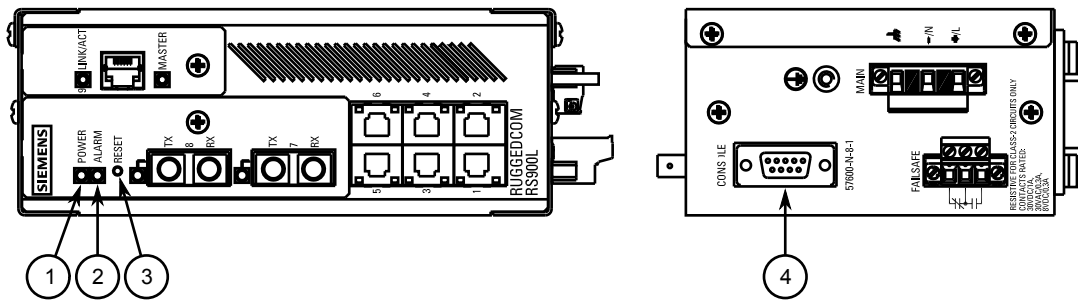

Figure 1: Front Panel

1. Power Indicator LEDs 2. Alarm Indicator LED 3. Reset Button 4. RS232 Serial Console Port

Power Indicator LEDs	The power indicator LED illuminates when power is being supplied to the device.
Alarm Indicator LED	The alarm indicator LED illuminates when an alarm condition exists.
Reset Button	The reset button shuts down and restarts the device.
RS232 Serial Console Port	This port is for interfacing directly with the device and accessing initial management functions.

2 Installing the Device

The following sections describe how to install the device, including mounting the device, installing/removing modules, connecting power, and connecting the device to the network.



WARNING!

Radiation hazard – risk of serious personal injury. This product contains a laser system and is classified as a CLASS 1 LASER PRODUCT. Use of controls or adjustments or performance of procedures other than those specified herein may result in hazardous radiation exposure.



DANGER!

Electrocution hazard – risk of serious personal injury and/or damage to equipment. Before performing any maintenance tasks, make sure all power to the device has been disconnected and wait approximately two minutes for any remaining energy to dissipate.



IMPORTANT!

This product contains no user-serviceable parts. Attempted service by unauthorized personnel shall render all warranties null and void.

Changes or modifications not expressly approved by Siemens AG could invalidate specifications, test results, and agency approvals, and void the user's authority to operate the equipment.



IMPORTANT!

This product should be installed in a restricted access location where access can only be gained by authorized personnel who have been informed of the restrictions and any precautions that must be taken. Access must only be possible through the use of a tool, lock and key, or other means of security, and controlled by the authority responsible for the location.

- [Section 2.1, “Mounting the Device”](#)
- [Section 2.2, “Connecting Power”](#)
- [Section 2.3, “Connecting the Failsafe Alarm Relay”](#)
- [Section 2.4, “Connecting to the Device”](#)
- [Section 2.5, “Cabling Recommendations”](#)

Section 2.1

Mounting the Device

The RS900L is designed for maximum mounting and display flexibility. It can be equipped with connectors that allow it to be installed in a 35 mm (1.4 in) DIN rail or directly on a panel.



NOTE

For detailed dimensions of the device with either DIN rail or panel hardware installed, refer to [Chapter 5, Dimension Drawings](#).

The following sections describe the various methods of mounting the device:

- [Section 2.1.1, “Mounting the Device on a DIN Rail”](#)
- [Section 2.1.2, “Mounting the Device to a Panel”](#)

Section 2.1.1

Mounting the Device on a DIN Rail

For DIN rail installations, the RS900L can be equipped with a DIN rail bracket pre-installed on the back of the chassis. The bracket allows the device to be slid onto a standard 35 mm (1.4 in) DIN rail.

To mount the device to a DIN rail, do the following:

1. Align the slot in the bracket with the DIN rail.

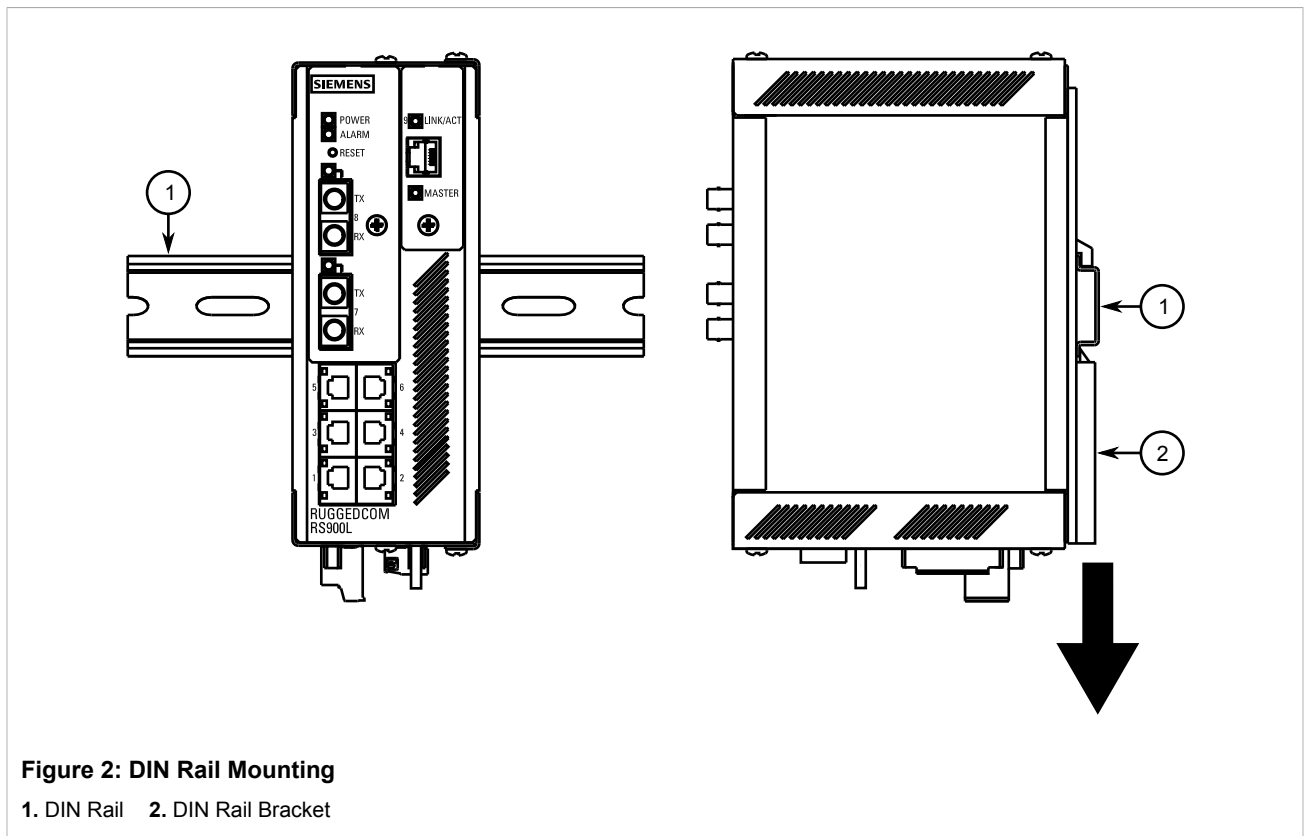

2. Pull the release on the bracket down and slide the device onto the DIN rail. Let go of the release to lock the device in position.

Section 2.1.2

Mounting the Device to a Panel

For panel installations, the RS900L can be equipped with panel adapters pre-installed on the top and bottom of the chassis. The adapters allow the device to be attached to a panel using screws.

To mount the device to a panel, do the following:

1. Place the device against the panel and align the adapters with the mounting holes.

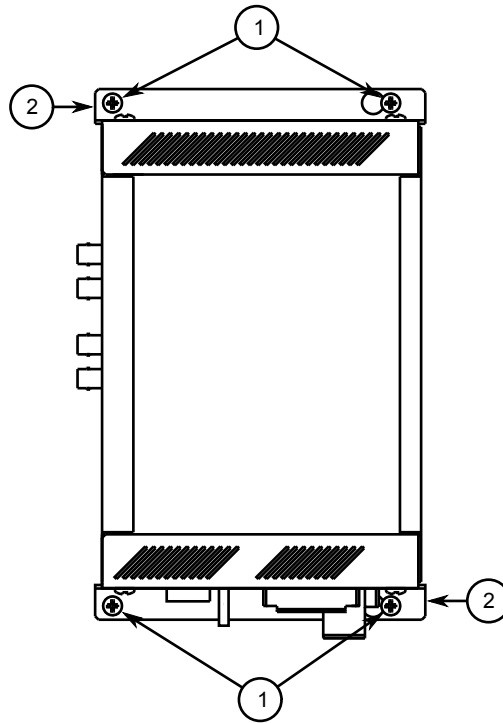

Figure 3: Panel Mounting

1. Screw 2. Panel Adaptor

2. Install the supplied screws to secure the adaptors to the panel.

Section 2.2

Connecting Power

The RS900L supports a single integrated high AC/DC or low DC power supply



NOTE

- For 110/230 VAC rated equipment, an appropriately rated AC circuit breaker must be installed.
- For 125/250 VDC rated equipment, an appropriately rated DC circuit breaker must be installed.
- Equipment must be installed according to applicable local wiring codes and standards.
- All line-to-ground transient energy is shunted to the Surge Ground terminal. In cases where users require the inputs to be isolated from ground, remove the ground braid between Surge and Chassis Ground. Note that all line-to-ground transient protection circuitry will be disabled.



IMPORTANT!

Siemens requires the use of external surge protection in VDSL applications where the line may be subject to surges greater than that for which the device is rated. Use the following specifications as a guide for VDSL external surge protection:

- Clamping Voltage: 50 V to 200 V

- *Insertion Loss: < 0.1 dB at 10 MHz*
- *Peak Surge Current: 10 kA, 8x20µs waveform*

The following sections describe how to connect power to the device:

- [Section 2.2.1, “Connecting High AC/DC Power”](#)
- [Section 2.2.2, “Connecting Low DC Power”](#)

Section 2.2.1

Connecting High AC/DC Power

To connect a high AC/DC power supply to the device, do the following:



CAUTION!

Electrical hazard – risk of damage to equipment. Do not connect AC power cables to terminals for DC power. Damage to the power supply may occur.



CAUTION!

Electrical hazard – risk of damage to equipment. Before testing the dielectric strength (HIPOT) in the field, remove the braided ground cable connected to the surge ground terminal and chassis ground. This cable connects transient suppression circuitry to chassis ground and must be removed in order to avoid damage to transient suppression circuitry during testing.

1. Connect the positive wire from the power source to the positive/live (+/L) terminal on the terminal block.

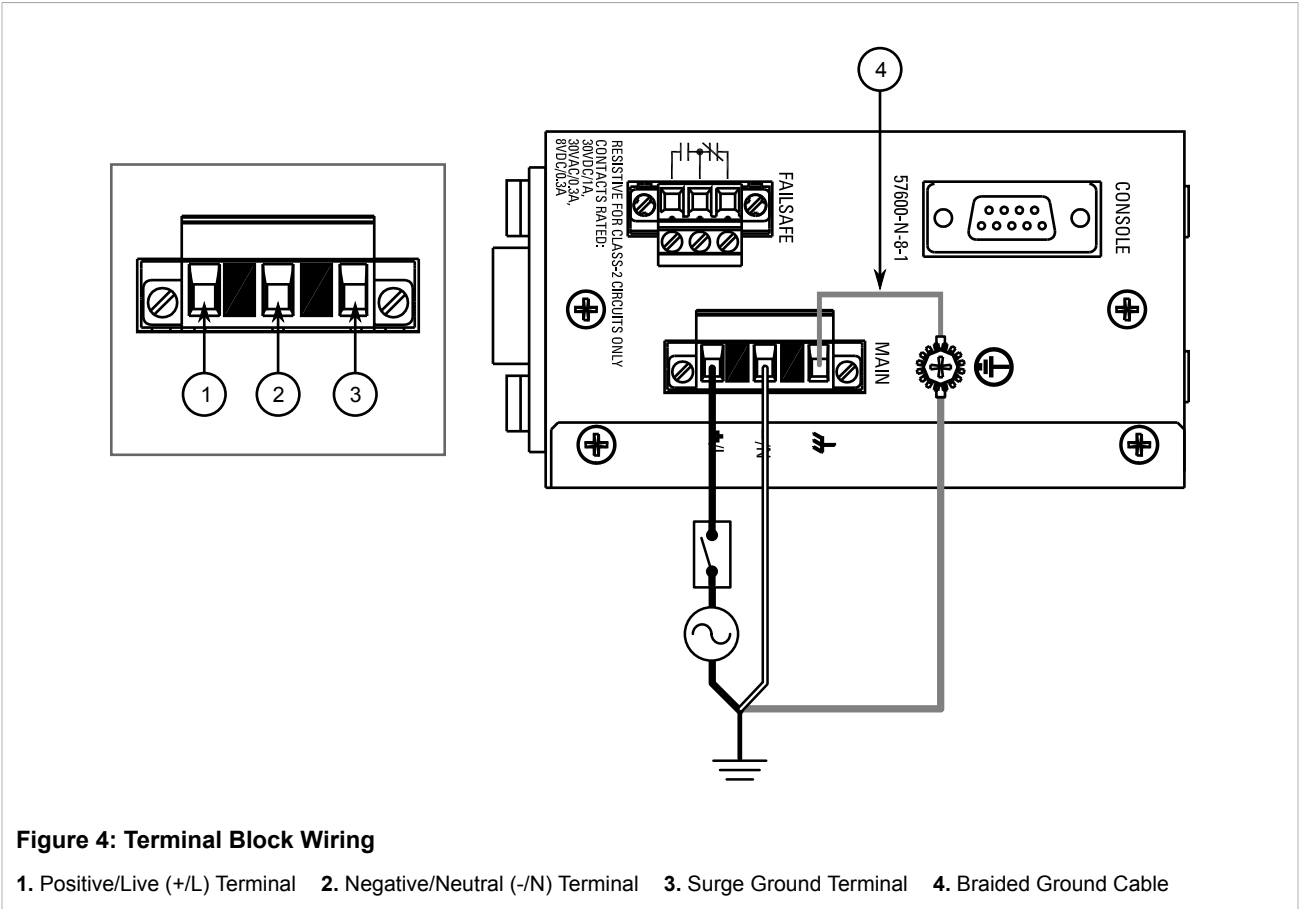

2. Connect the negative wire from the power source to the negative/neutral (-/N) terminal on the terminal block.
3. Using a braided wire or other appropriate grounding wire, connect the surge ground terminal to the chassis ground connection. The surge ground terminal is used as the ground conductor for all surge and transient suppression circuitry internal to the unit.
4. Connect the ground terminal on the power source to the chassis ground terminal on the device.

Section 2.2.2

Connecting Low DC Power

To connect a low DC power supply to the device, do the following:



CAUTION!

Electrical hazard – risk of damage to equipment. Before testing the dielectric strength (HIPOT) in the field, remove the braided ground cable connected to the surge ground terminal and chassis ground. This cable connects transient suppression circuitry to chassis ground and must be removed in order to avoid damage to transient suppression circuitry during testing.

1. Connect the positive wire from the power source to the positive terminal on the terminal block.

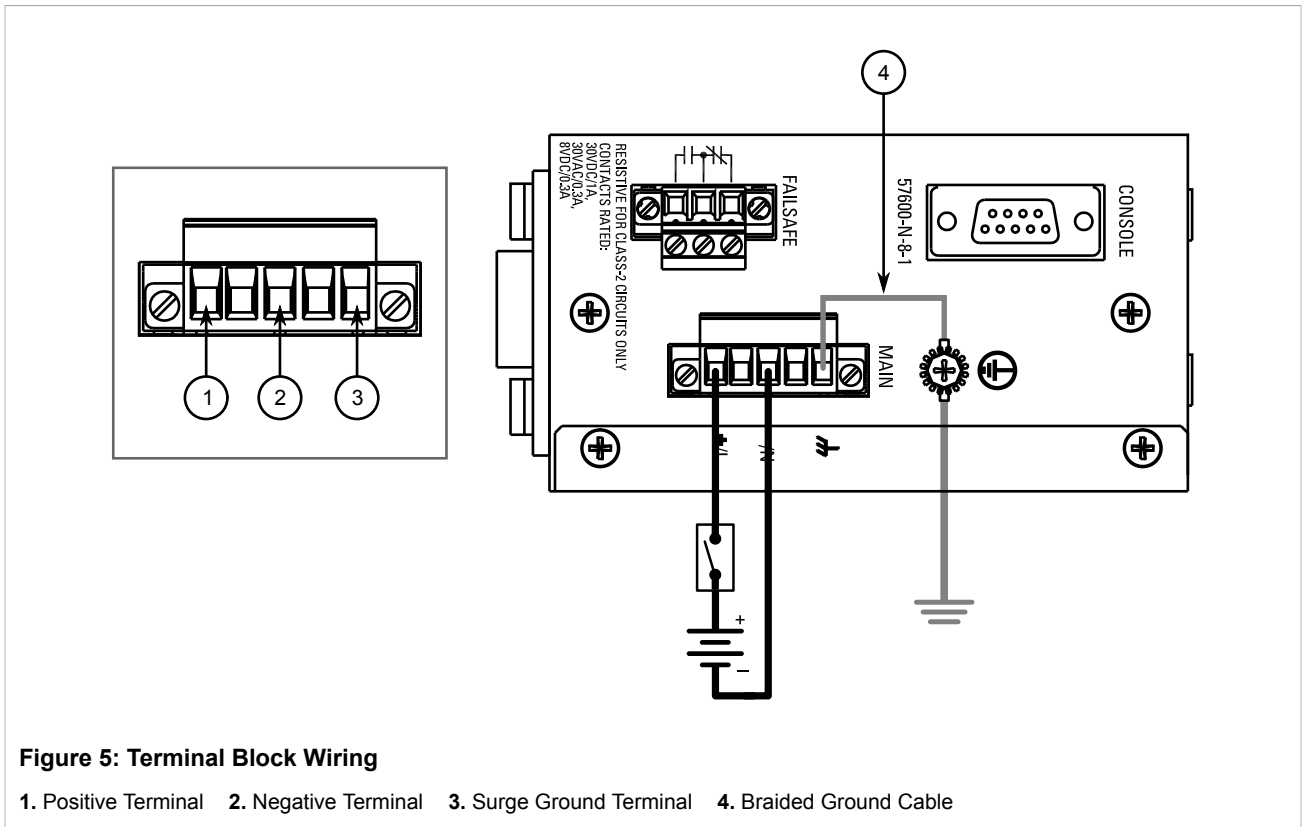

2. Connect the negative wire from the power source to the negative terminal on the terminal block.
3. Using a braided wire or other appropriate grounding wire, connect the surge ground terminal to the chassis ground connection. The surge ground terminal is used as the ground conductor for all surge and transient suppression circuitry internal to the unit.
4. Connect the ground terminal on the power source to the chassis ground terminal on the device.

Section 2.3

Connecting the Failsafe Alarm Relay

The failsafe relay can be configured to latch based on alarm conditions. The NO (Normally Open) contact is closed when the unit is powered and there are no active alarms. If the device is not powered or if an active alarm is configured, the relay opens the NO contact and closes the NC (Normally Closed) contact.



NOTE

Control of the failsafe relay output is configurable through ROS . One common application for this relay is to signal an alarm if a power failure occurs. For more information, refer to the ROS User Guide for the RS900L.

The following shows the proper relay connections.

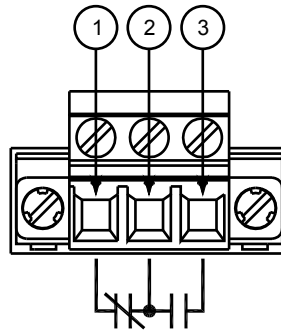

Figure 6: Failsafe Alarm Relay Wiring

1. Normally Open 2. Common 3. Normally Closed

Section 2.4

Connecting to the Device

The following describes the various methods for accessing the ROS console and Web interfaces on the device. For more detailed instructions, refer to the *ROS User Guide* for the RS900L.

Serial Console Port

Connect a PC or terminal directly to the serial console port to access the boot-time control and ROS console interface.



IMPORTANT!

The serial console port is intended to be used only as temporary connections during initial configuration or troubleshooting.

The serial console port implements RS232 DCE (Data Communication Equipment) on a DB9 connector. The following is the pin-out for the port:

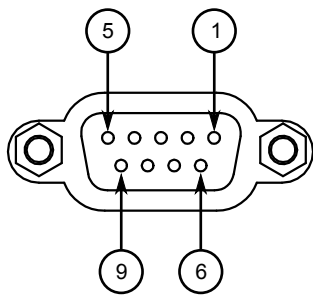

Figure 7: Serial DB9 Console Port

Pin	Name	Description
1	DCD	Data Carrier Detect
2	RX	Receive Data
3	TX	Transmit Data
4	DTR	Data Terminal Ready
5	GND	Signal Ground
6	DSR	Data Set Ready
7	RTS	Request to Send
8	CTS	Clear To Send
9		Reserved (Do Not Connect)

Communication Ports

Connect any of the available Ethernet ports on the device to a management switch and access the ROS console and Web interfaces via the device's IP address. For more information about available ports, refer to [Chapter 3, Communication Ports](#).

Section 2.5

Cabling Recommendations

Siemens does not recommend the use of copper cabling of any length for critical, real-time substation automation applications. All copper Ethernet ports on RUGGEDCOM products include transient suppression circuitry to protect against damage from electrical transients and conform with IEC 61850-3 and IEEE 1613 Class 1 standards. This means that during a transient electrical event, communications errors or interruptions may occur, but recovery is automatic.

Siemens also does not recommend using copper Ethernet ports to interface with devices in the field across distances that could produce high levels of ground potential rise (i.e. greater than 2500 V), during line-to-ground fault conditions.

3 Communication Ports

The RS900L can be equipped with various types of communication ports to enhance its abilities and performance. To determine which ports are equipped on the device, refer to the factory data file available through ROS . For more information on how to access the factory data file, refer to the *ROS User Guide* for the RS900L.

Each communication port type has a specific place in the RS900L chassis.

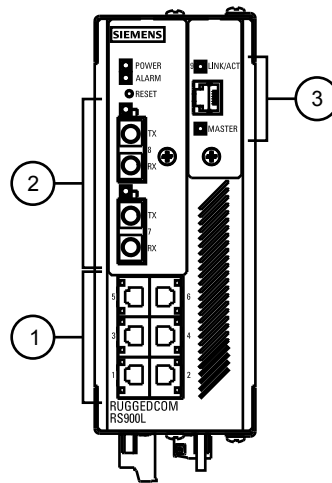

Figure 8: Port Assignment

1. Ports 1 to 6 2. Ports 7 to 8 3. Port 9

Port	Type
1 to 6	Fast Ethernet Ports (10/100Base-TX)
7 to 8	Fast Ethernet Ports (10/100Base-TX or 10/100Base-FX)
9	EoVDSL Port

The following sections describe the available ports:

- [Section 3.1, “Copper Ethernet Ports”](#)
- [Section 3.2, “Fiber Optic Ethernet Ports”](#)
- [Section 3.3, “EoVDSL Ports”](#)

Section 3.1

Copper Ethernet Ports

The RS900L supports several 10/100Base-TX Ethernet ports that allow connection to standard Category 5 (CAT-5) unshielded twisted-pair (UTP) cables with RJ45 male connectors. The RJ45 receptacles are directly connected to the chassis ground on the device and can accept CAT-5 shielded twisted-pair (STP) cables.



WARNING!

Electric shock hazard – risk of serious personal injury and/or equipment interference. If shielded cables are used, make sure the shielded cables do not form a ground loop via the shield wire and the RJ45 receptacles at either end. Ground loops can cause excessive noise and interference, but more importantly, create a potential shock hazard that can result in serious injury.

Each port features a **Speed** and **Link** LED that indicates the state of the port.

LED	State	Description
Speed	Yellow	The port is operating at 100 Mbps
	Off	The port is operating at 10 Mbps
Link	Yellow (Solid)	Link established
	Yellow (Blinking)	Link activity
	Off	No link detected

The following is the pin-out for the RJ45 male connectors:

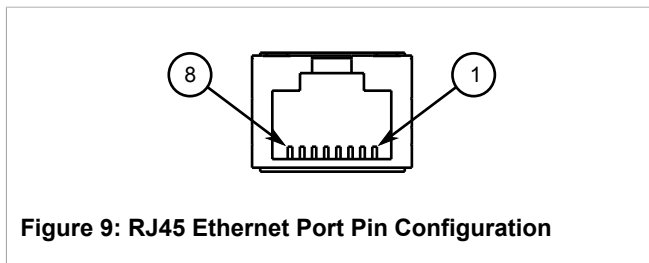

Figure 9: RJ45 Ethernet Port Pin Configuration

Pin	Name	Description
1	RX+	Receive Data+
2	RX-	Receive Data-
3	TX+	Transmit Data+
4		Reserved (Do Not Connect)
5		Reserved (Do Not Connect)
6	TX-	Transmit Data-
7		Reserved (Do Not Connect)
8		Reserved (Do Not Connect)

For specifications on the available copper Ethernet ports, refer to [Section 4.3, “Copper Ethernet Port Specifications”](#).

Section 3.2

Fiber Optic Ethernet Ports

Fiber optic Ethernet ports are available with either MTRJ (Mechanical Transfer Registered Jack), LC (Lucent Connector), SC (Standard or Subscriber Connector) or ST (Straight Tip) connectors. Make sure the Transmit (Tx) and Receive (Rx) connections of each port are properly connected and matched to establish a proper link.

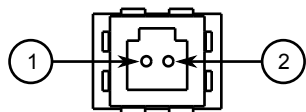

Figure 10: MTRJ Port

1. Tx Connector 2. Rx Connector

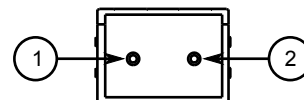

Figure 11: LC Port

1. Tx Connector 2. Rx Connector

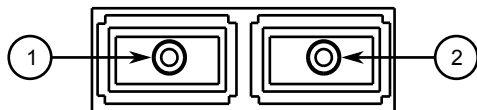

Figure 12: SC Port

1. Tx Connector 2. Rx Connector

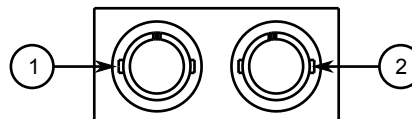

Figure 13: ST Port

1. Tx Connector 2. Rx Connector

For specifications on the available fiber optic Ethernet ports, refer to [Section 4.4, “Fiber Optic Ethernet Port Specifications”](#).

Section 3.3

EoVDSL Ports

Ethernet over VDSL (EoVDSL) ports operate in pairs with one device configured as the Master and the other as the Slave. In VDSL (Very-high-bit-rate Digital Subscriber Line), the terms Central Office (CO) or Line Termination (LT) are used interchangeably for the Master and the terms Customer Premise Equipment (CPE) or Network Termination (NT) are used interchangeably for the Slave. The Master device dictates the line configuration settings to the Slave so all EoVDSL configuration is done on the Master. Data flowing from the Master to the Slave is designated *downstream* while data flowing from the Slave to the Master is designated *upstream*.

Siemens offers two flavors of VDSL: Universal EoVDSL and Long-Reach EoVDSL. Universal EoVDSL ports are Master/Slave selectable and offer symmetric data rates up to 35 Mbps with distances up to 2.5 km (1.6 mi). Long-Reach EoVDSL ports are fixed as either Master or Slave but offer asymmetric data rates up to 40 Mbps with distances up to 5 km (3.1 mi).

The Universal and Long-Reach EoVDSL ports are physically indistinguishable from each other. However, the port type can be determined either from the order code or through ROS.

EoVDSL ports can be connected using RJ11 male connectors. Each EoVDSL port has a **Link/Act** LED and a **Master** LED. On devices with Universal EoVDSL ports, the **Master** LED can be toggled on or off depending on whether the port is set to be a Master or Slave. On devices with Long-Reach EoVDSL ports, the **Master** LED will be on all the time if the device is set to be the Master, or off if the device is set to be the Slave.

Status LED	State	Description
Master	Green (Solid)	The device is in Master mode.
	Off	The device is in Slave mode.
Link/Act	Green (Solid)	Link established
	Green (Blinking)	Link activity

Status LED	State	Description
	Off	No link detected



NOTE

All RJ11 connectors conform to the standard telephony pin configuration.

The following is the pin-out for the RJ11 connectors:

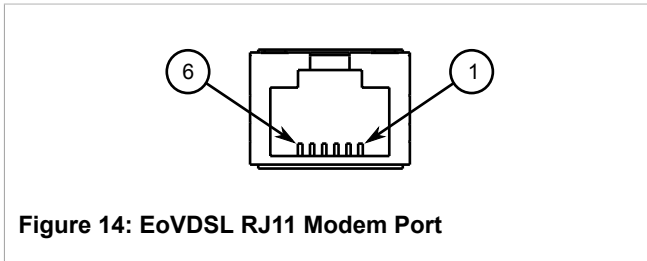

Pin	Description
1	Reserved (Do Not Connect)
2	Reserved (Do Not Connect)
3	Ring
4	Tip
5	Reserved (Do Not Connect)
6	Reserved (Do Not Connect)

The following sections describe the EoVDSL ports in more detail:

- [Section 3.3.1, “EoVDSL Wiring”](#)
- [Section 3.3.2, “Configuration and Setup”](#)
- [Section 3.3.3, “EoVDSL Performance”](#)

Section 3.3.1

EoVDSL Wiring

VDSL operates over 2-wire Category 3 (CAT-3) or higher twisted-pair wiring. Other twisted-pair wiring with similar characteristics may work, although the performance will vary depending on the cable characteristics and distance.

When wiring EoVDSL ports, note the following:

- Twisted-pairs are an effective way of reducing both magnetic and capacitive interference because they reduce the magnetic loop area to nearly zero and maintain a consistent distribution of capacitances to both ground and other sources. Therefore, make sure twisting is consistent throughout cable length.
- Open leads (also known as bridged taps or drop-lines) along the length of the cable will cause an impedance mismatch and result in VDSL signal degradation.
- Make sure the cable impedance is consistent throughout the run. Avoid mixing different wiring (e.g. wiring with different gages) in cable runs, as this will cause an impedance mismatch and result in VDSL signal degradation.
- Make sure wiring is adequately separated between power and control circuits. Switching spikes and surges in power and control circuits can couple noise onto the VDSL line, causing interruptions in communications.
- Lower speeds are less susceptible to interference and will transmit greater distances over the same wiring than higher speeds. Use the minimum speed that will provide adequate data transfer speed.

Section 3.3.2

Configuration and Setup

If the RS900L and another device both have Universal EoVDSL ports, configure one device to be the Master and the other the Slave. If both devices have a Long-Reach EoVDSL port, no Master/Slave configuration is necessary, since the ports will already be fixed as Master or Slave. Once configured and connected together, each device will attempt to achieve the maximum speed based on the line length and conditions. The device's link LED may flash on and off several times before setting on a final link speed and declaring the port up. For more information about configuring the RS900L, refer to the *ROS User Guide for RS900LW/RS930LW*.

Section 3.3.3

EoVDSL Performance

The EoVDSL ports can be configured to operate in one of two modes: Auto Mode (default) and Manual Mode. In Auto Mode, the device will step through the different speeds and automatically select the best bit-rate based on the current line conditions. In Manual Mode, the user can select one of the speed settings and the device will only attempt to attain the set speed. If the line conditions degrade (reducing the SNR or Signal to Noise Ratio), but the device is able to maintain the link, an alarm will be triggered to notify the user of the reduced SNR. By configuring the **Rescan Mode** parameter in ROS, the user can control at which point the scan process will be restarted when the line conditions degrade. If **Link only** is selected, the device will restart the scan process if the line conditions degrade such that the device is unable to maintain the current link. If **Link or SNR** is selected, the device will restart the scan process if either the SNR has dropped below a pre-defined acceptable level or when the device is unable to maintain the current link, or whichever comes first. Note that if **Mode** is set to **Manual Mode**, the restart of the scan process will only attempt to attain the set speed in Manual Mode.

For information about configuring EoVDSL, refer to the *RUGGEDCOM ROS for the RS900L*.

**NOTE**

- *EoVDSL ports are designed to be used on private communications lines for point-to-point connections and are not to be connected to the Public Switched Telephone Network (PSTN).*
- *To reduce the risk of fire, use only No. 26 AWG or larger telecommunication line cord.*
- *In Manual Mode, assuming the distance can support the speed setting, the time to port up is typically 15-30 seconds.*

On 24 American Wire Gage (AWG) Polyethylene Insulated Cable (PIC) twisted-pair wiring, the following performance is typical with Universal EoVDSL ports:

Distance (km)	Distance (feet)	Downstream / Upstream (Mbps)	Time to Achieve Port Up in Auto Mode (Seconds)
0.50	1600	35	15
0.60	2000	30	30
0.70	2300	25	45
0.90	3000	20	60
1.00	3300	15	75
1.30	4300	10	90
1.70	5600	5	105
2.00	6600	2.5	120

Distance (km)	Distance (feet)	Downstream / Upstream (Mbps)	Time to Achieve Port Up in Auto Mode (Seconds)
2.50	8200	1.2	150

The following performance is typical with Long-Reach EoVDSL ports:

Distance (km)	Distance (feet)	Downstream (Master to Slave) (Mbps)	Upstream (Slave to Master) (Mbps)	Time to Achieve Port Up in Auto Mode (Seconds)
0.50	1600	40	20	15
1.00	3300	25	5	30
1.50	4900	20	0.54	45
2.00	6600	15	0.54	60
2.50	8200	10	0.54	75
3.20	10500	5	0.54	90
4.00	13100	2.1	0.54	105
4.60	15100	1.2	0.54	120
5.00	16400	0.48	0.18	150

4 Technical Specifications

The following sections provide important technical specifications related to the device and available modules:

- [Section 4.1, “Power Supply Specifications”](#)
- [Section 4.2, “Failsafe Relay Specifications”](#)
- [Section 4.3, “Copper Ethernet Port Specifications”](#)
- [Section 4.4, “Fiber Optic Ethernet Port Specifications”](#)
- [Section 4.5, “Operating Environment”](#)
- [Section 4.6, “Mechanical Specifications”](#)

Section 4.1

Power Supply Specifications

Power Supply Type	Input Range		Internal Fuse Rating ^{ab}	Isolation	Maximum Power Consumption ^c
	Minimum	Maximum			
HI	88 VDC	300 VDC	3.15 A(T)	4 kVAC	10 W
	85 VAC	264 VAC		5.5 kVDC	
24	10 VDC	36 VDC		1.5 kVDC	
48	36 VDC	72 VDC		1.5 kVDC	

^a (F) denotes fast-acting fuse

^b (T) denotes time-delay fuse.

^c Power consumption varies based on configuration.

Section 4.2

Failsafe Relay Specifications

Parameter	Value (Resistive Load)
Max Switching Voltage	30 VAC, 80 VDC
Rated Switching Current	0.3 A @ 30 VAC 1 A @ 30 VDC, 0.3 A @ 80 VDC
Isolation	1500 V _{rms} ^d

^d Dielectric test voltage (1 minute) between coil and contacts

Section 4.3

Copper Ethernet Port Specifications

The following details the specifications for copper Ethernet ports that can be ordered with the RS900L.

Order Code	Speed ^e	Connector	Duplex ^e	Cable Type ^f	Wiring Standard ^g	Maximum Distance ^h	Isolation ⁱ
TX	10/100TX	DB9	FDX/HDX	> Category 5	TIA/EIA T568A/B	100 m (328 ft)	1.5 kV

^e Auto-negotiating.

^f Shielded or unshielded.

^g Auto-crossover and auto-polarity.

^h Typical distance. Dependent on the number of connectors and splices.

ⁱ RMS 1 minute.

Section 4.4

Fiber Optic Ethernet Port Specifications

The following details the specifications for fiber Ethernet ports that can be ordered with the RS900L.



NOTE

Order codes are contained within each product when assembled and configured at the factory. Refer to the ROS User Guide for the RS900L for information on how to obtain the factory configuration data.



NOTE

- All optical power numbers are listed as dBm averages. To convert from average to peak add 3 dBm. To convert from peak to average, subtract 3 dBm.
- Maximum segment length is greatly dependent on factors such as fiber quality, and the number of patches and splices. Consult a Siemens sales associate when determining maximum segment distances.

Order Code	Mode	Connector Type	Cable Type (µm)	Tx λ (typ.) (nm)	Tx min. (dBm)	Tx max. (dBm)	Rx Sensitivity (dBm)	Rx Saturation (dBm)	Distance (typ.) (km)	Power Budget (dB)
MJ	MM	MTRJ	1300	50/125	-22.5	-14	-33.5	-14	2	11
				62.5/125	-19	-14	-33.5	-14	2	14.5
MC	MM	SC	1300	50/125	-22.5	-14	-33.9	-14	2	11.4
				62.5/125	-19	-14	-33.9	-14	2	14.9
MT	MM	ST	1300	50/125	-22.5	-14	-33.9	-14	2	11.4
				62.5/125	-19	-14	-33.9	-14	2	14.9
ML	MM	LC	1310	62.5/125	-19	-14	-32	-14	2	13
T2	SM	ST	1310	9/125	-15	-7	-34	-3	20	19
L2	SM	LC	1300	9/125	-15	-8	-38	-3	20	23

Order Code	Mode	Connector Type	Cable Type (μm)	Tx λ (typ.) (nm)	Tx min. (dBm)	Tx max. (dBm)	Rx Sensitivity (dBm)	Rx Saturation (dBm)	Distance (typ.) (km)	Power Budget (dB)
L5	SM	LC	1310	9/125	-5	0	-35	-3	50	30
L9	SM	LC	1310	9/125	0	5	-37	0	90	37
C2	SM	SC	1300	9/125	-15	-8	-31	-7	20	16
C5	SM	SC	1310	9/125	-5	0	-34	-3	50	29
C9	SM	SC	1310	9/125	5	0	-37	0	90	42

Section 4.5

Operating Environment

Parameter	Range	Comments
Ambient Operating Temperature	-40 to 85 °C (-40 to 185 °F)	Measured from a 30 cm (12 in) radius surrounding the center of the enclosure.
Ambient Relative Humidity	5% to 95%	Non-condensing
Ambient Storage Temperature	-40 to 85 °C (-40 to 185 °F)	

Section 4.6

Mechanical Specifications

Parameter	Value
Dimensions	Refer to Chapter 5, Dimension Drawings
Weight	1.2 kg (2.7 lbs)
Ingress Protection	IP40 (1 mm or 0.04 in objects)
Enclosure	20 AWG Galvanized Steel

5 Dimension Drawings



NOTE

All dimensions are in millimeters, unless otherwise stated.

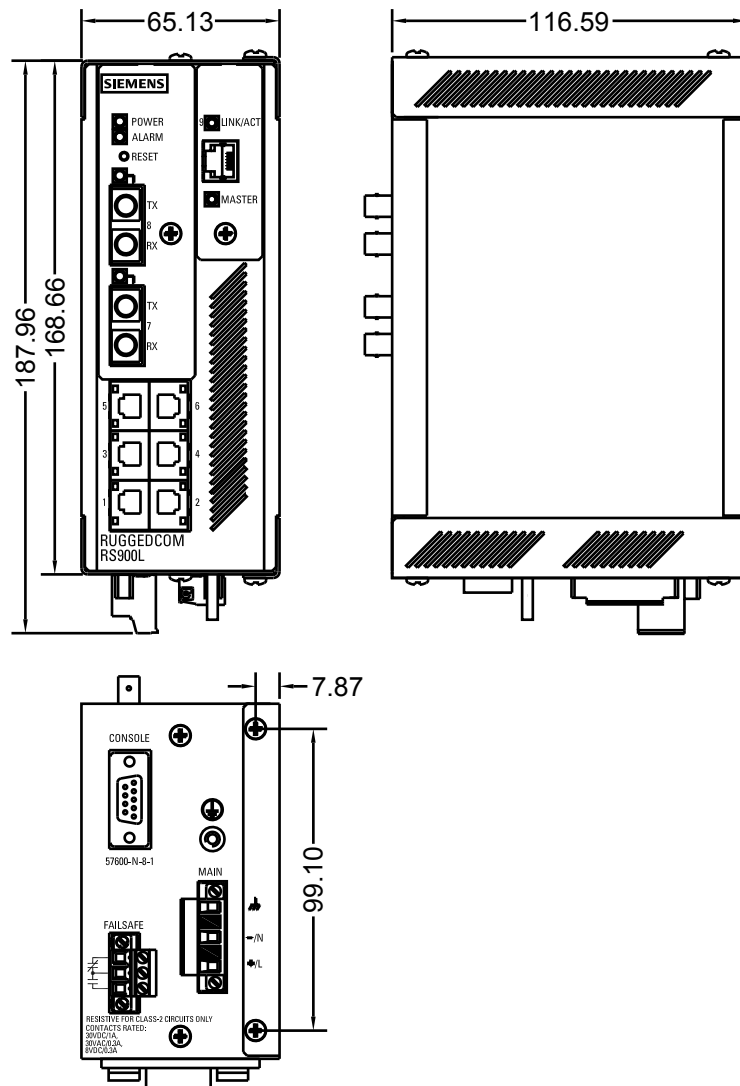

Figure 15: Overall Dimensions

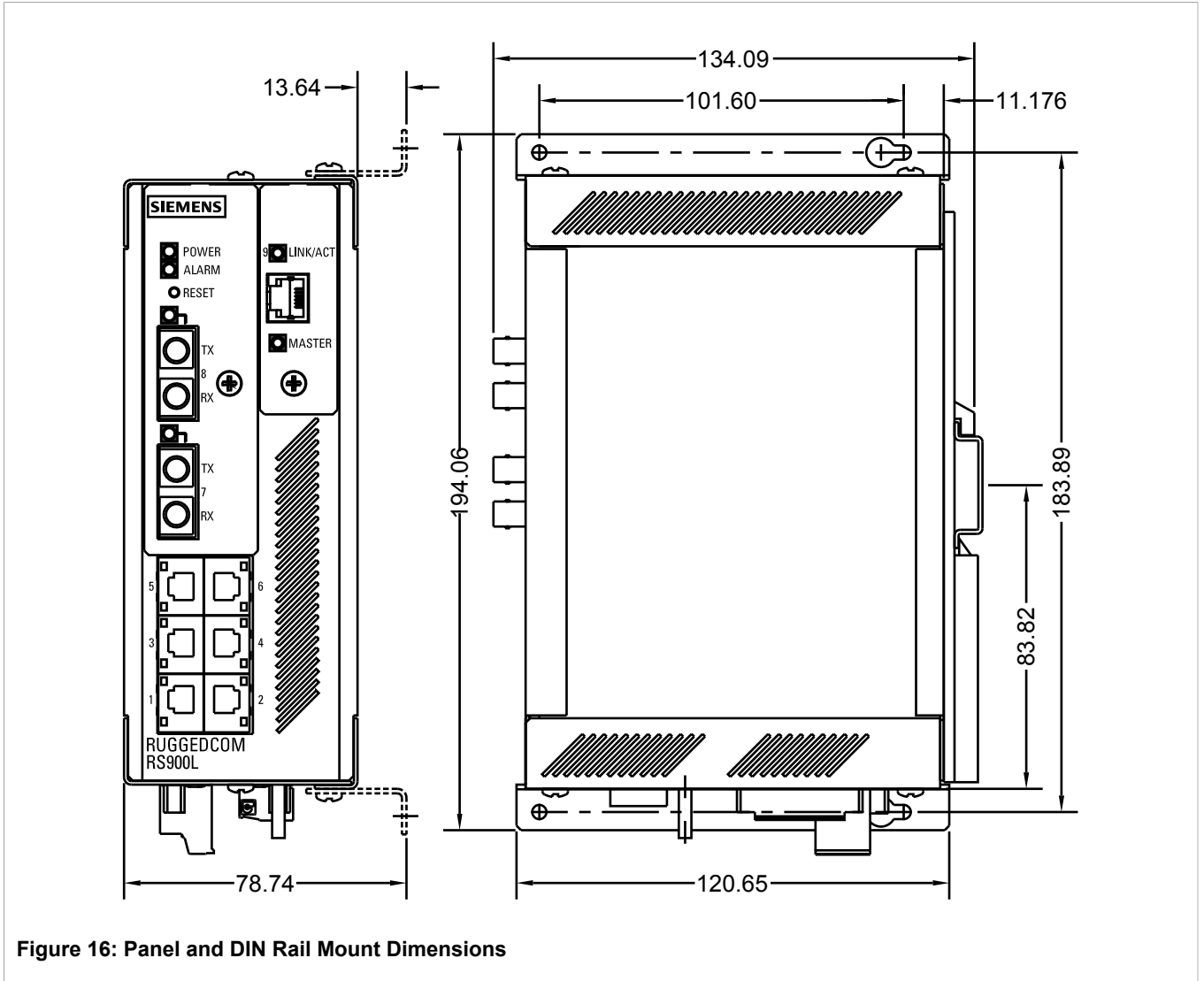

Figure 16: Panel and DIN Rail Mount Dimensions

6 Certification

The RS900L device has been thoroughly tested to guarantee its conformance with recognized standards and has received approval from recognized regulatory agencies.

- [Section 6.1, “Agency Approvals”](#)
- [Section 6.2, “FCC Compliance”](#)
- [Section 6.3, “Industry Canada Compliance”](#)
- [Section 6.4, “EMI and Environmental Type Tests”](#)

Section 6.1

Agency Approvals

Agency	Standards	Comments
CSA	CSA C22.2 No. 60950-1, UL 60950-1	Approved
CE	EN 60950-1, EN 61000-6-2, EN60825-1, EN55022 Class A, EN 50581	CE Compliance is claimed via Declaration of Self Conformity Route
FCC	FCC Part 15, Class A	Approved
FDA/CDRH	21 CFR Chapter I, Sub-chapter J	Approved

Section 6.2

FCC Compliance

This equipment has been tested and found to comply with the limits for a Class A digital device pursuant to Part 15 of the FCC Rules. These limits are designed to provide reasonable protection against harmful interference when the equipment is operated in a commercial environment.

This equipment generates, uses and can radiate radio frequency energy and, if not installed and used in accordance with the instruction manual, may cause harmful interference to radio communications. Operation of this equipment in a residential area is likely to cause harmful interference in which case the user will be required to correct the interference on his own expense.

Section 6.3

Industry Canada Compliance

CAN ICES-3 (A) / NMB-3 (A)

Section 6.4

EMI and Environmental Type Tests

The RS900L has passed the following EMI and environmental tests.

IEC 61850-3 Type Tests

Test	Description	Test Levels	Severity Levels	
IEC 61000-4-2	ESD	Enclosure Contact	+/- 8 kV	4
		Enclosure Air	+/- 15 kV	4
IEC 61000-4-3	Radiated RFI	Enclosure ports	20 V/m	x
IEC 61000-4-4	Burst (Fast Transient)	Signal ports	+/- 4 kV @ 2.5 kHz	x
		DC Power ports	+/- 4 kV	4
		AC Power ports	+/- 4 kV	4
		Earth ground ports	+/- 4 kV	4
IEC 61000-4-5	Surge	Signal ports	+/- 4 kV line-to-earth, +/- 2 kV line-to-line	4
		DC Power ports	+/- 2 kV line-to-earth, +/- 1 kV line-to-line	3
		AC Power ports	+/- 4 kV line-to-earth, +/- 2 kV line-to-line	4
IEC 61000-4-6	Induced (Conducted) RFI	Signal ports	10 V	3
		DC Power ports	10 V	3
		AC Power ports	10 V	3
		Earth ground ports	10 V	3
IEC 61000-4-8	Magnetic Field	Enclosure ports	40 A/m continuous, 1000 A/m for 1 s	
IEC 61000-4-29	Voltage Dips and Interrupts	DC Power ports	30% for 0.1 s, 60% for 0.1 s, 100% for 0.05 s	
		AC Power ports	30% for 1 period, 60% for 50 periods	
IEC 61000-4-11			100% for 5 periods, 100% for 50 periods	
IEC 61000-4-12	Damped Oscillatory	Signal ports	2.5 kV common, 1 kV differential mode @ 1 MHz	3
		DC Power ports	2.5 kV common, 1 kV differential mode @ 1 MHz	3
		AC Power ports	2.5 kV common, 1 kV differential mode @ 1 MHz	3
IEC 61000-4-16	Mains Frequency Voltage	Signal ports	30 V Continuous, 300 V for 1 s	4
		DC Power ports	30 V Continuous, 300 V for 1 s	4
IEC 61000-4-17	Ripple on DC Power Supply	DC Power ports	10%	3

Test	Description		Test Levels	Severity Levels
IEC 60255-5	Dielectric Strength	Signal ports	2 kVAC (Fail-Safe Relay output)	
		DC Power ports	1.5 kVDC	
		AC Power ports	2 kVDC	
	HV Impulse	Signal ports	5 kV (Fail-Safe Relay Output)	
		DC Power ports	5 kV	
		AC Power ports	5 kV	

IEEE 1613 (C37.90.x) EMI Immunity Type Tests



NOTE

The RS900L meets Class 2 requirements for an all-fiber configuration and Class 1 requirements for copper ports.

IEEE Test	IEEE 1613 Clause	Description		Test Levels
C37.90.3	9	ESD	Enclosure Contact	+/- 8 kV
			Enclosure Air	+/- 15 kV
C37.90.2	8	Radiated RFI	Enclosure ports	35 V/m
C37.90.1	7	Fast Transient	Signal ports	+/- 4 kV @ 2.5 kHz
			DC Power ports	+/- 4 kV
			AC Power ports	+/- 4 kV
			Earth ground ports	+/- 4 kV
		Oscillatory	Signal ports	2.5 kV common mode @ 1MHz
			DC Power ports	2.5 kV common and differential mode @ 1MHz
C37.90	6	HV Impulse	Signal ports	5 kV (Failsafe Relay)
			DC Power ports	5 kV
			AC Power ports	5 kV
		Dielectric Strength	Signal ports	2 kVAC (Failsafe Relay)
			DC Power ports	1.5 kVDC
			AC Power ports	2 kVAC

Environmental Type Tests

Test	Description		Test Levels	Severity Levels
IEC 60068-2-1	Cold Temperature	Test Ad	-40 °C (-40 °F), 16 Hours	
IEC 60068-2-2	Dry Heat	Test Bd	85 °C (185 °F), 16 Hours	

Test	Description		Test Levels	Severity Levels
IEC 60068-2-30	Humidity (Damp Heat, Cyclic)	Test Db	95% (non-condensing), 55 °C (131 °F), 6 cycles	
IEC 60255-21-1	Vibration		2 g @ 10-150 Hz	Class 2
IEC 60255-21-2	Shock		30 g @ 11 ms	Class 2