



JetBox 5630 HW User Manual

www.korenix.com

Copyright Notice

Copyright© 2014 Korenix Technology Co., Ltd.

All rights reserved.

Reproduction without permission is prohibited.

Information provided in this manual is intended to be accurate and reliable. However, the original manufacturer assumes no responsibility for its use, or for any infringements upon the rights of third parties that may result from its use.

The material in this document is for product information only and is subject to change without notice. While reasonable efforts have been made in the preparation of this document to assure its accuracy, Korenix assumes no liabilities resulting from errors or omissions in this document, or from the use of the information contained herein.

Korenix reserves the right to make changes in the product design without notice to its users.

Acknowledgments

Korenix is a registered trademark of Korenix Technology Co., Ltd.

All other trademarks or registered marks in the manual belong to their respective manufacturers.

Table of Content

	Copyright Notice	2
	Acknowledgments.....	2
	Table of Content	3
Chapter 1	Overview	4
Chapter 2	Hardware Specification	5
Chapter 3	Hardware Feature	7
3-1	Mechanical Outline	7
3-2	Front Panel.....	9
3-3	Bottom View	10
3-4	Wiring the Power Inputs	10
3-5	Grounding JetBox.....	10
3-6	I/O Connectors	11
3-6-1	Ethernet (RJ-45)	11
3-6-2	SFP.....	11
3-6-3	USB 2.0 (HOST).....	11
3-6-4	RS232/422/485 (DB9)	12
3-6-5	Console.....	12
3-6-6	Reset Button	12
3-6-7	SD Card Slot.....	12
3-7	JetBox 5633Gf-w USB Holder.....	13
3-8	System Login	15
Chapter 4	Customer Service	15

Chapter 1 Overview

One of the advantages of adopting Korenix JetBox series industrial computers is ready-to-use. All these years, Korenix is devoted to enhance usability and functions of embedded computers in industrial domain. Korenix operating system provides device drivers, protocol stacks, system utilities, supporting services and daemons to make system integration simple. Besides, Korenix also provides application development toolkits for users to build their own applications easily.

The stylish compact JetBox 5630Gf-w series are industrial layer 3 VPN routers with Linux computing capability. It is a gateway to connect different network groups such as Ethernet and serial control in a complex networking architecture and manage peripherals at the front-end site. With Gigabit Ethernet, fiber connection and ability of network redundancy, JetBox 5630Gf-w series can be applied in crossroads or highway for flow control and traffic monitoring of remote transportation control. Besides, JetBox 5630Gf-w series are designed with features of compact, reliable and robust to adopt in various industrial vertical markets with hazardous environment such as transportation, surveillance and environmental monitoring.

Chapter 2 Hardware Specification

	JetBox 5630Gf-w	JetBox 5633Gf-w
Interface		
Ethernet Switch LAN	10/100/1000 Base-TX RJ-45 x3 Built-in 15KV ESD protection of all signals	10/100/1000 Base-TX RJ-45 x3 Built-in 15KV ESD protection of all signals
WAN	100/1000 Mbps SFP fiber/ 10/100/1000 Base-TX RJ45 combo x1	100/1000 Mbps SFP fiber/ 10/100/1000 Base-TX RJ45 combo x1
RS232/422/485	x1 (DB9), default RS232, RS485 support 4-wire only	x1 (DB9), default RS232, RS485 support 4-wire only
USB 2.0 (Host)	x1, Supporting devices: USB flash, wireless dongle	x3, Supporting devices: USB flash, wireless dongle
SD card slot	x1	x1
Wireless	--	USB x2 for 3G/Wifi/GPRS dongle expansion
System		
Processor	TI AM3352 720MHz ARM Cortex-A8	TI AM3352 720MHz ARM Cortex-A8
System memory	512MB DDR2 SDRAM	512MB DDR2 SDRAM
System flash	256MB, up to 100MB free space for customized program storage	256MB, up to 100MB free space for customized program storage
Console	3-pin header (RS232 interface)	3-pin header (RS232 interface)
LED per RJ45 port (on the port)	<ul style="list-style-type: none"> ■ Ethernet Port: Link (Green on) / Activity (Green blinking) ■ Ethernet Speed: 1000Mbps (Amber on) / 10 or 100Mbps (Amber off) 	<ul style="list-style-type: none"> ■ Ethernet Port: Link (Green on) / Activity (Green blinking) ■ Ethernet Speed: 1000Mbps (Amber on) / 10 or 100Mbps (Amber off)
LED per unit	<ul style="list-style-type: none"> ■ Power Status, System: On (Green on) ■ 2 x Status for Customization (Green or Amber) ■ Fiber Status: 1000Mbps (Green on) / 100Mbps (Amber on) 	<ul style="list-style-type: none"> ■ Power Status, System: On (Green on) ■ 2 x Status for Customization (Green or Amber) ■ Fiber Status: 1000Mbps (Green on) / 100Mbps (Amber on)
RTC	Battery backup external RTC	Battery backup external RTC
Battery	Ultra-Capacitor (DIP type)	Ultra-Capacitor (DIP type)
Watchdog timer	Embedded hardware watchdog timer to auto reset system when system failure	Embedded hardware watchdog timer to auto reset system when system failure
Power on/off switch	x1	x1

Reset button	x1, reboot: 3 seconds/reset default: 7 seconds	x1, reboot: 3 seconds/reset default: 7 seconds
DC input	DC 9~36V power input with polarity auto reverse protection	DC 9~36V power input with polarity auto reverse protection
Power consumption	10W	18W
ME		
Housing IP rating	IP30 Sheet Metal	IP30 Sheet Metal
Color	Silver	Silver
Dimension (mm)	160(H) x 118(D) x 47(W)	160(H) x 118(D) x 80(W)
Net weight	0.9kg	1.2kg
Mounting	DIN-rail	DIN-rail
Operating temp.	-40 ~ 75°C, 0 ~ 95% RH	-40 ~ 75°C, 0 ~ 95% RH
Storage temp.	-40 ~ 80°C, 0 ~ 95% RH	-40 ~ 80°C, 0 ~ 95% RH
OS support		
Embedded Linux	JetOS56 (kernel 3.2)	JetOS56 (kernel 3.2)
Certificate		
EMI	CISPR 16-1-2/ 16-2-1/ 16-2-3 / 22, FCC Part 15 Subpart B Class A, ANSI C63.4 Heavy Industrial IEC/EN61000-6-4	CISPR 16-1-2/ 16-2-1/ 16-2-3 / 22, FCC Part 15 Subpart B Class A, ANSI C63.4 Heavy Industrial IEC/EN61000-6-4
EMS	Heavy Industrial IEC/EN 61000-6-2, IEC 61000-4-2, IEC 61000-4-3, IEC 61000-4-4, IEC 61000-4-5, IEC 61000-4-6, IEC 61000-4-8, IEC 61000-4-9	Heavy Industrial IEC/EN 61000-6-2, IEC 61000-4-2, IEC 61000-4-3, IEC 61000-4-4, IEC 61000-4-5, IEC 61000-4-6, IEC 61000-4-8, IEC 61000-4-9
Shock	IEC60068-2-27	IEC60068-2-27
Bump	IEC60068-2-29	IEC60068-2-29
Vibration	IEC60068-2-64	IEC60068-2-64
Free Fall	IEC60068-2-32	IEC60068-2-32
Railway EMC	EN50121-1/-4 (Compliance)	EN50121-1/-4 (Compliance)
Warranty	5 years	5 years

Chapter 3 Hardware Feature

3-1 Mechanical Outline

JetBox 5630Gf-w appearance



JetBox 5630Gf-w mechanical outline

(160 x 47 x 118 mm)

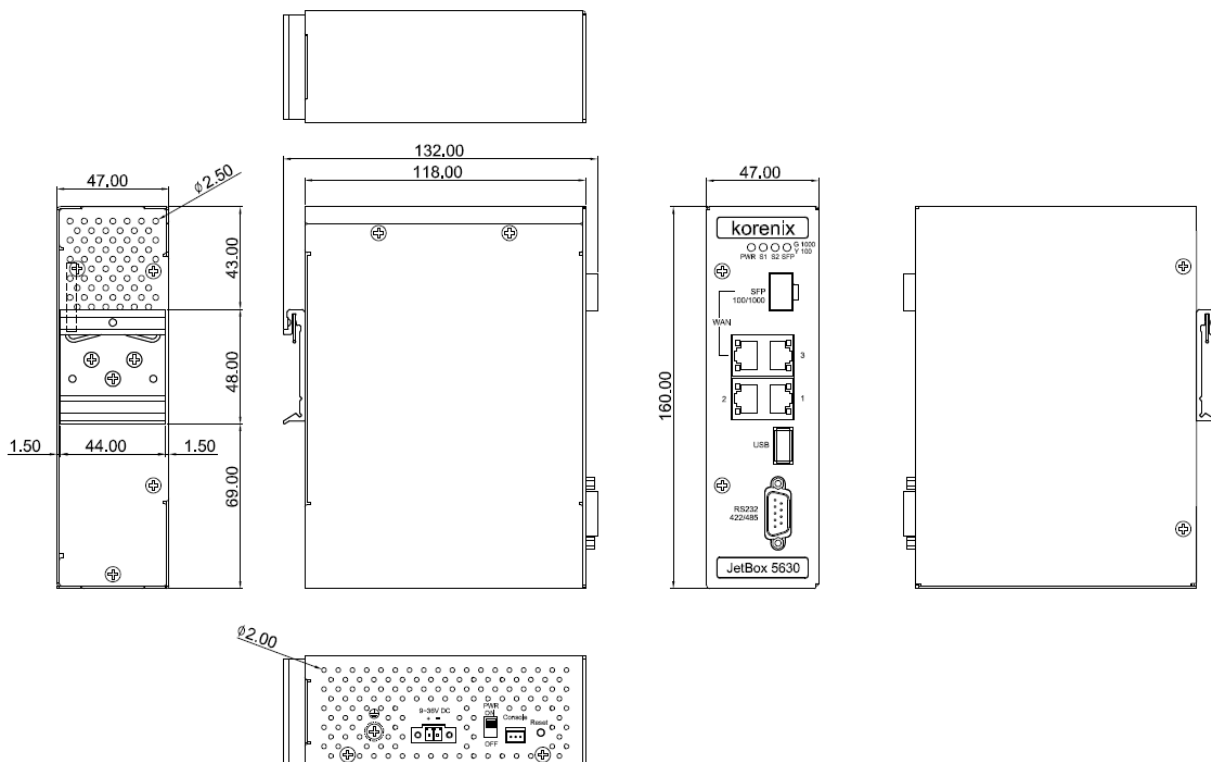

JetBox 5633Gf-w appearance



JetBox 5633Gf-w mechanical outline

(160 x 118 x 80 mm)

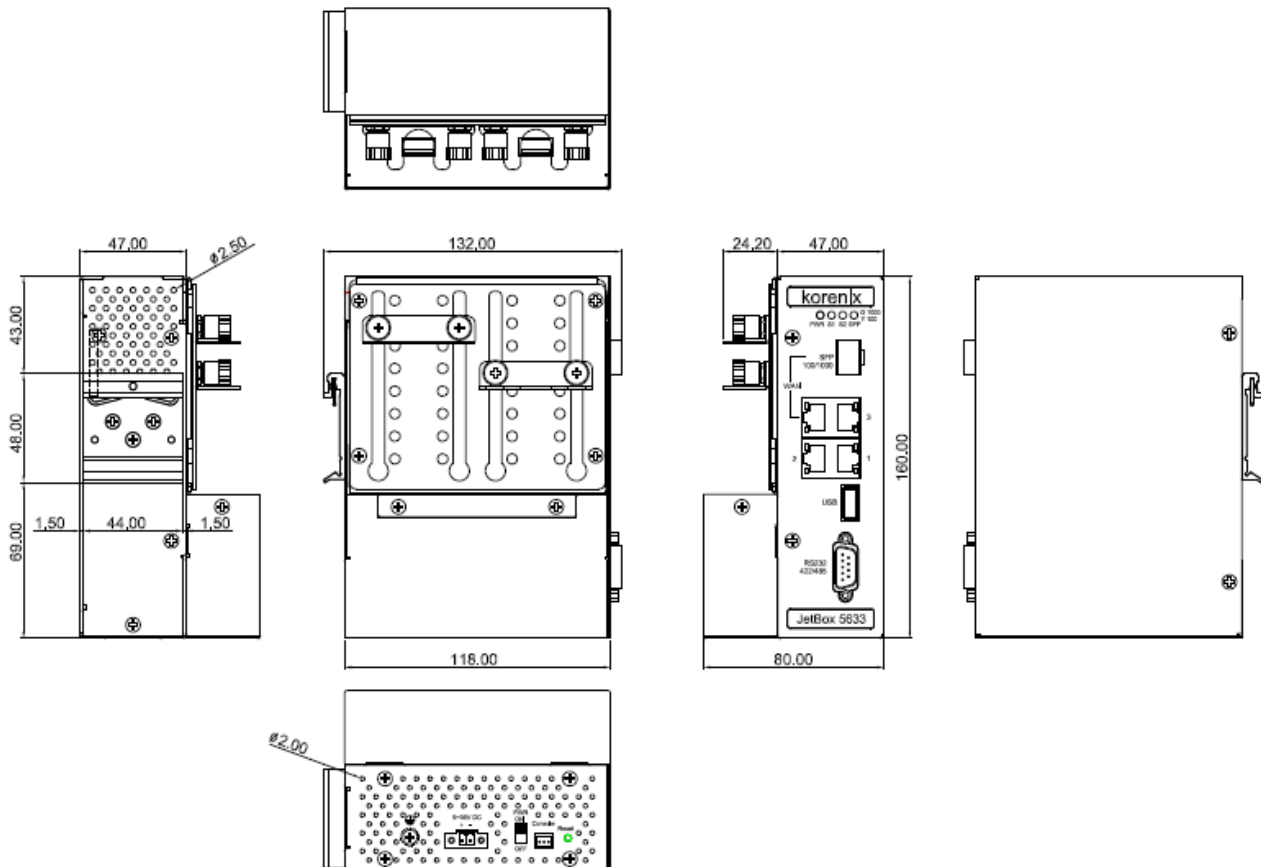

3-2 Front Panel

The front panel includes 3 x 10/100/100 RJ-45 LAN ports, 1 x Gigabit RJ-45/SFP combo WAN port, 1 x RS232/422/485, USB 2.0 sockets and diagnostic LEDs.

JetBox 5630Gf-w

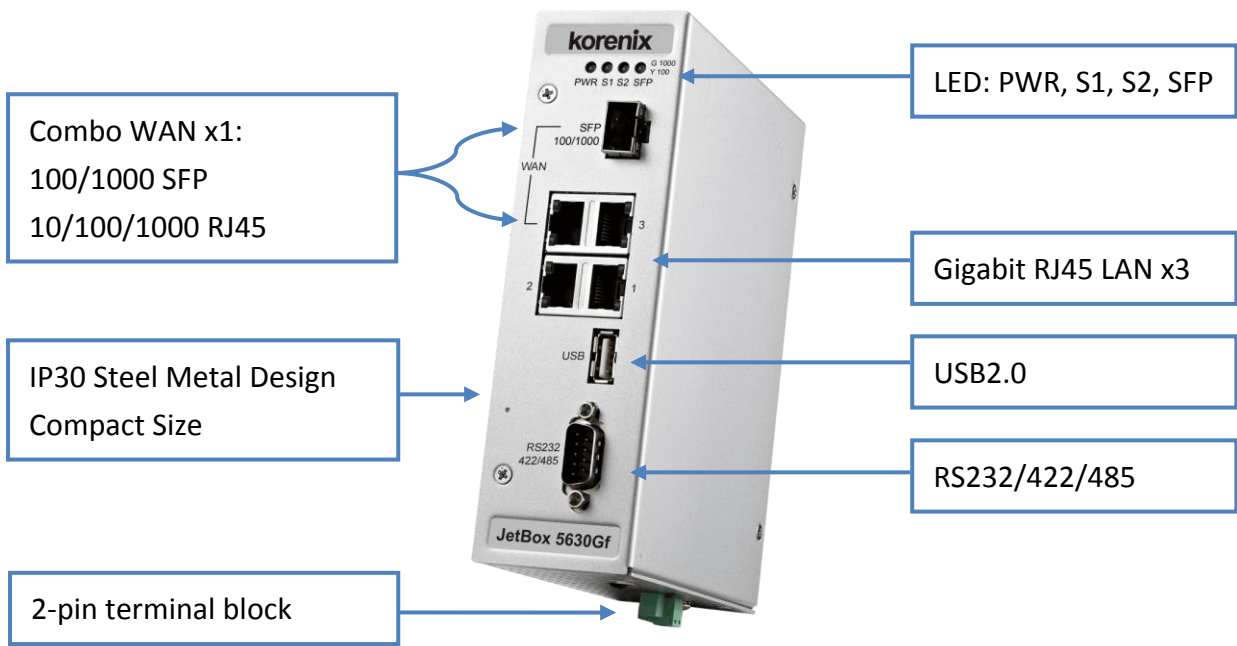

JetBox 5633Gf-w

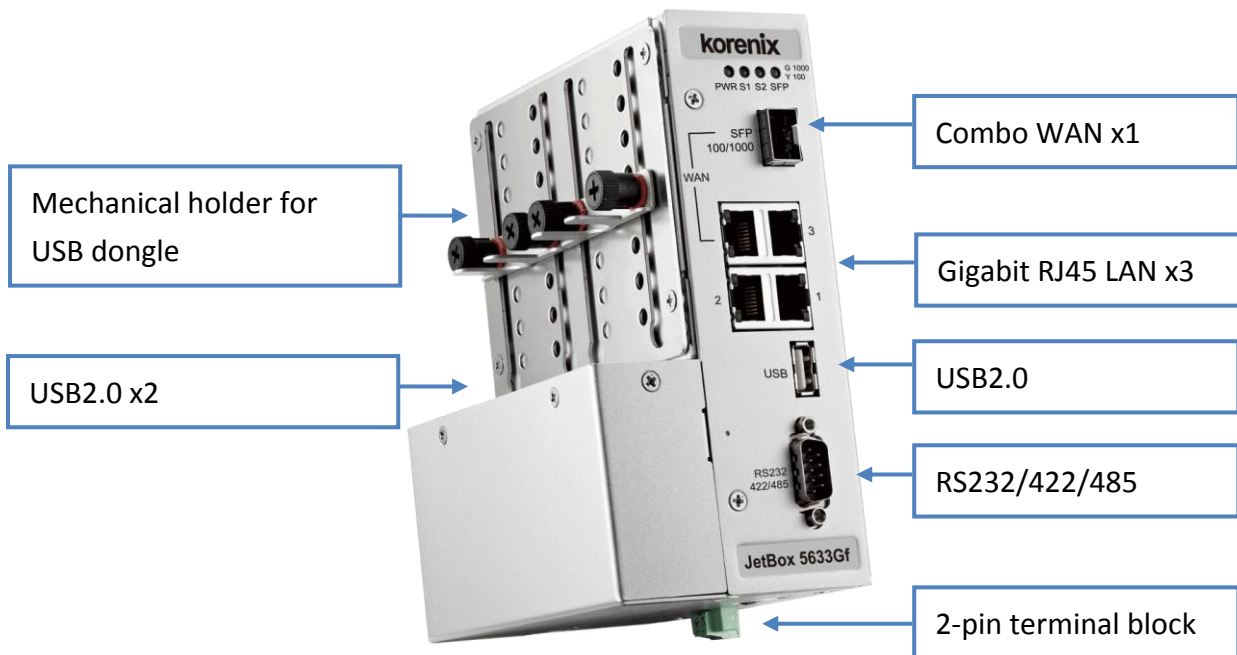

3-3 Bottom View

The bottom side of the JetBox 5630Gf-w series is shown below.

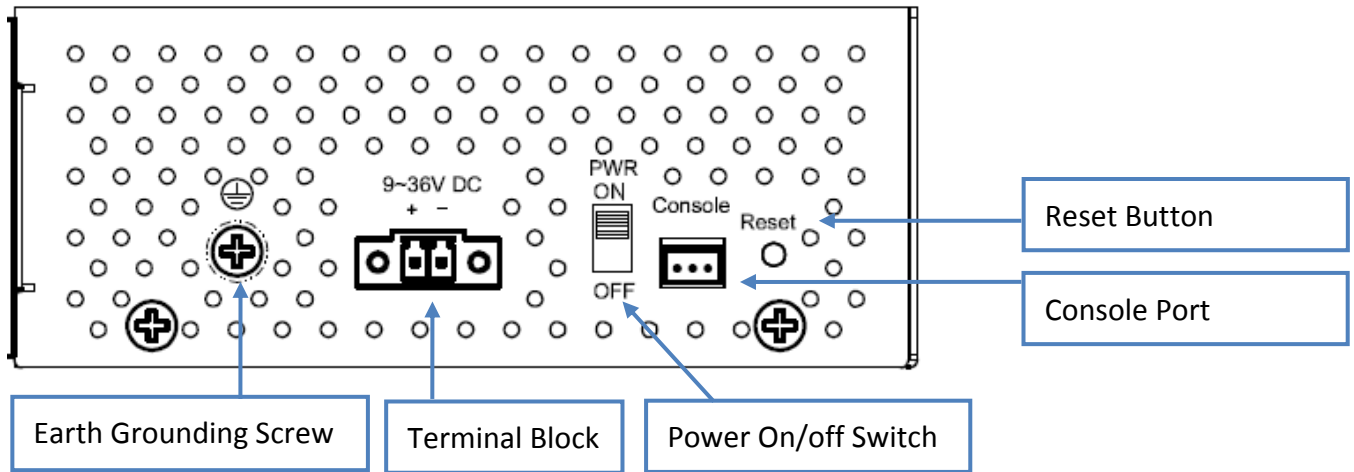

3-4 Wiring the Power Inputs

JetBox 5630Gf-w series accepts 9~36V DC power input.

1. Insert the positive and negative wires of your DC supply into the V+ and V- contacts of the terminal block connector. The recommended working voltage is DC24V (DC9~36V).
2. Tighten the terminal screws to prevent the DC wires from loosening.

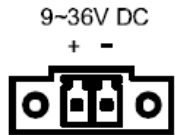

Pin	Signal Name
1	VCC
2	GND

3-5 Grounding JetBox

There is one grounding screw on the bottom side, and please connect the frame grounding of system to the grounding surface to ensure safety and prevent noise to interfere communication.

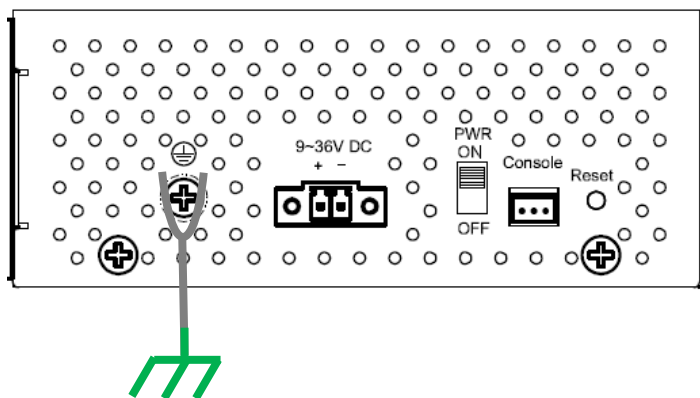

3-6 I/O Connectors

3-6-1 Ethernet (RJ-45)

JetBox 5630 series provide three RJ-45 LAN ports and one RJ-45/SFP combo WAN port. The RJ-45 is standard RJ-45 jack socket.

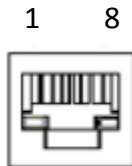

Pin	Signal Name
1	MDX0+
2	MDX0-
3	MDX1+
4	MDX2+
5	MDX2-
6	MDX1-
7	MDX3+
8	MDX3-

3-6-2 SFP

JetBox 5630 series provide one RJ-45/SFP combo WAN port. Please don't connect Ethernet RJ-45 and SFP transceiver at the same time or use wrong SFP spec which does not match with SFP speed setting, or exception conditions would happen. (Default speed: Gigabit)



To change SFP speed you need to reboot the system to make it effective.

ATTENTION

This is a Class 1 Laser/LED product.
Don't look into the Laser/LED Beam.

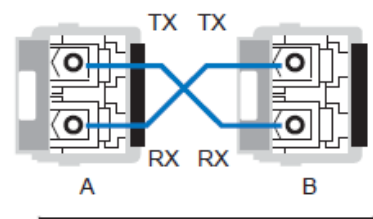

3-6-3 USB 2.0 (HOST)

USB type "A" female connectors for USB peripherals.

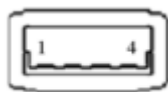

Pin	Signal Name
1	VCC
2	DATA-
3	DATA+
4	GND

3-6-4 RS232/422/485 (DB9)

JetBox 5630 series provide one serial port (DB9). (Default: RS232, RS485 support 4-wire only)

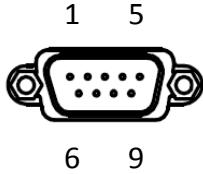

Pin	RS-232	RS-422	RS-485 (4-wire)
1	DCD	RXD-	RXD-
2	RXD	RXD+	RXD+
3	TXD	TXD+	TXD+
4	DTR	TXD-	TXD-
5	GND	GND	GND
6	DSR		
7	RTS		
8	CTS		
9	RI		

3-6-5 Console

JetBox provides one 3-pin connector Console port for debug use.

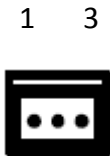

Pin	Signal Name
1	TXD
2	RXD
3	GND

3-6-6 Reset Button

This button is used to make the system reboot or reset to the factory default.

Press 3 seconds for system reboot.

Press 7 seconds to reset the JetBox to the factory default.

3-6-7 SD Card Slot

This socket is used for a SD Card and users can put their own applications in it.

To access the SD card, you can follow these steps:

1. Unscrew five screws of back cover (Please refer to the picture below).
2. Then remove the back cover and you can insert or take out the SD card.

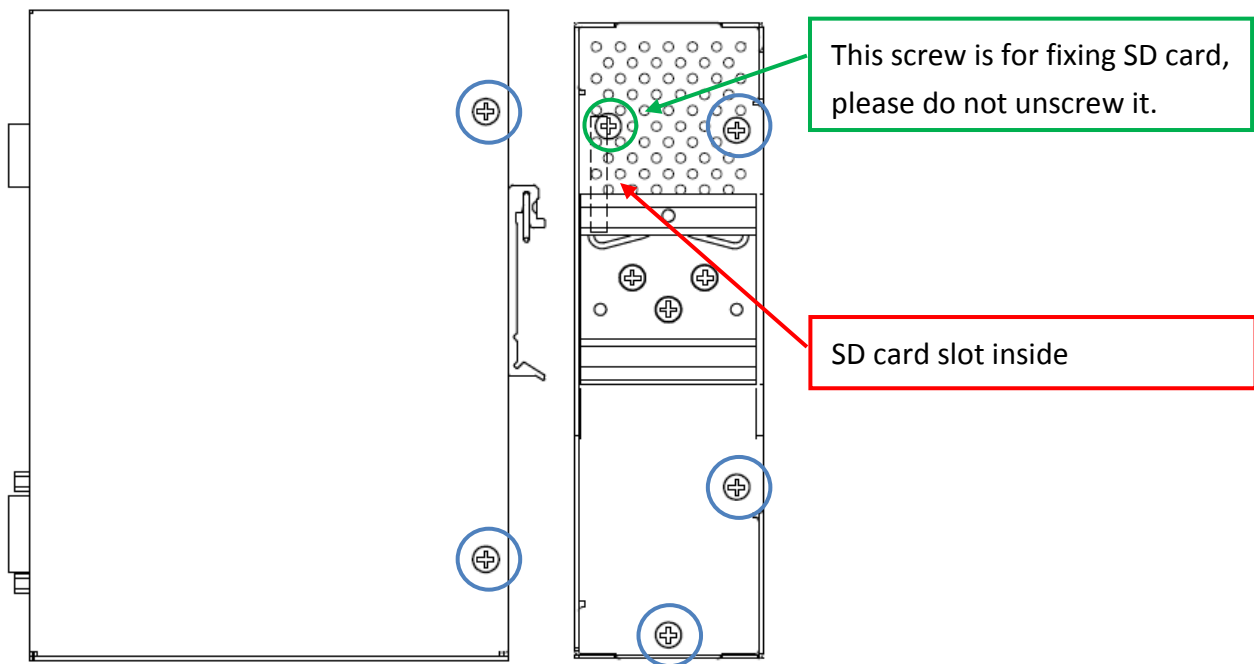

3-7 JetBox 5633Gf-w USB Holder

JetBox 5633Gf-w has extra two USB slots for 3G/wifi USB dongle expansion.

To tighten the USB dongle, you have two methods and you can follow these steps:

➤ **Use the platen to fix the dongle**

1. Slightly loosen the screws and move the platen to appropriate height according to the size of dongle.
2. Plug the dongle into USB socket.
3. Move the platen to press the dongle and tighten the screws.



Please do NOT loosen the screws too much or the kits would fall off from JetBox.

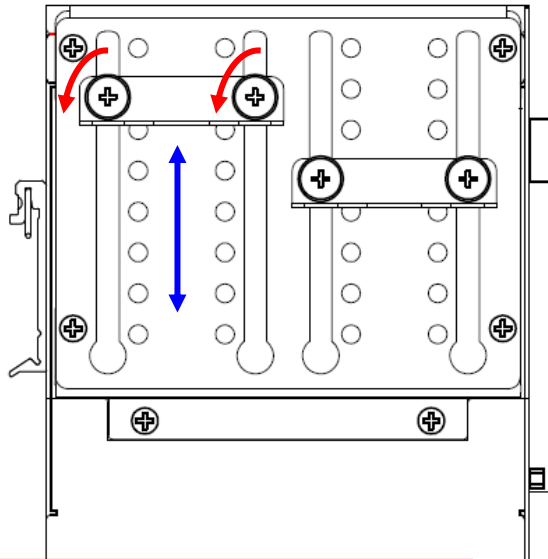

Loosen the screws and move the platen to appropriate height.

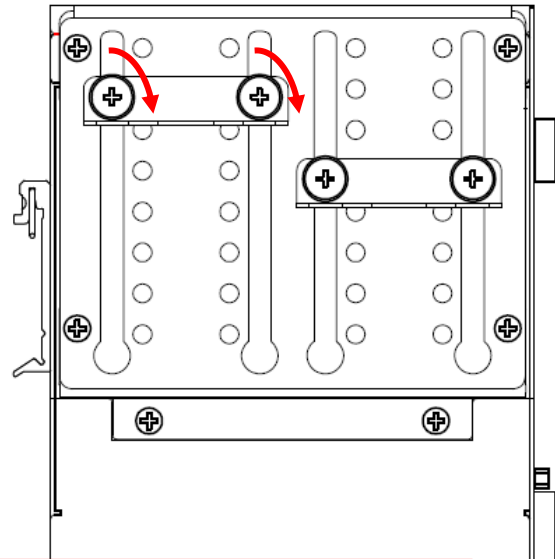

After plug the USB dongle, move the platen to press the dongle and tighten the screws.

➤ **Use cable ties to fix the dongle**

1. Take out the cable ties from accessories kit.
2. Use the cable tie to thread through the rear side of guide plate.
3. Surround the USB dongle then tie up the cable tie.

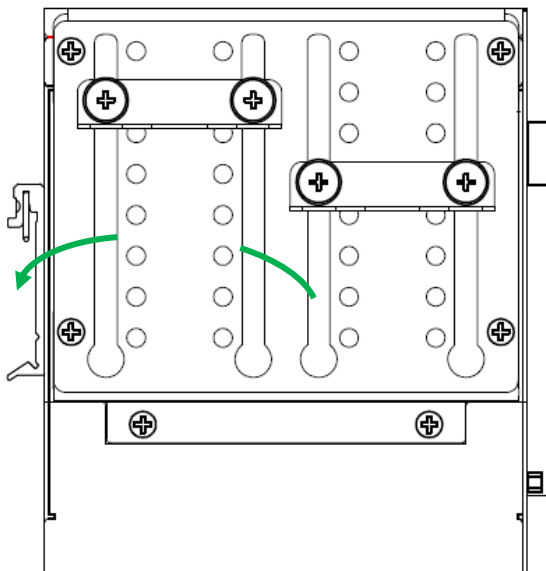

Use the cable tie to thread through the rear side of guide plate.

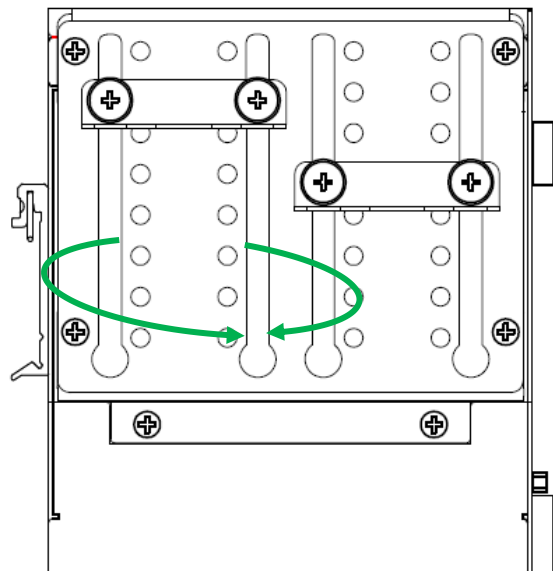

Surround the USB dongle then tie up the cable tie.

If the kits fall off from JetBox, you can refer to below picture to assembly.

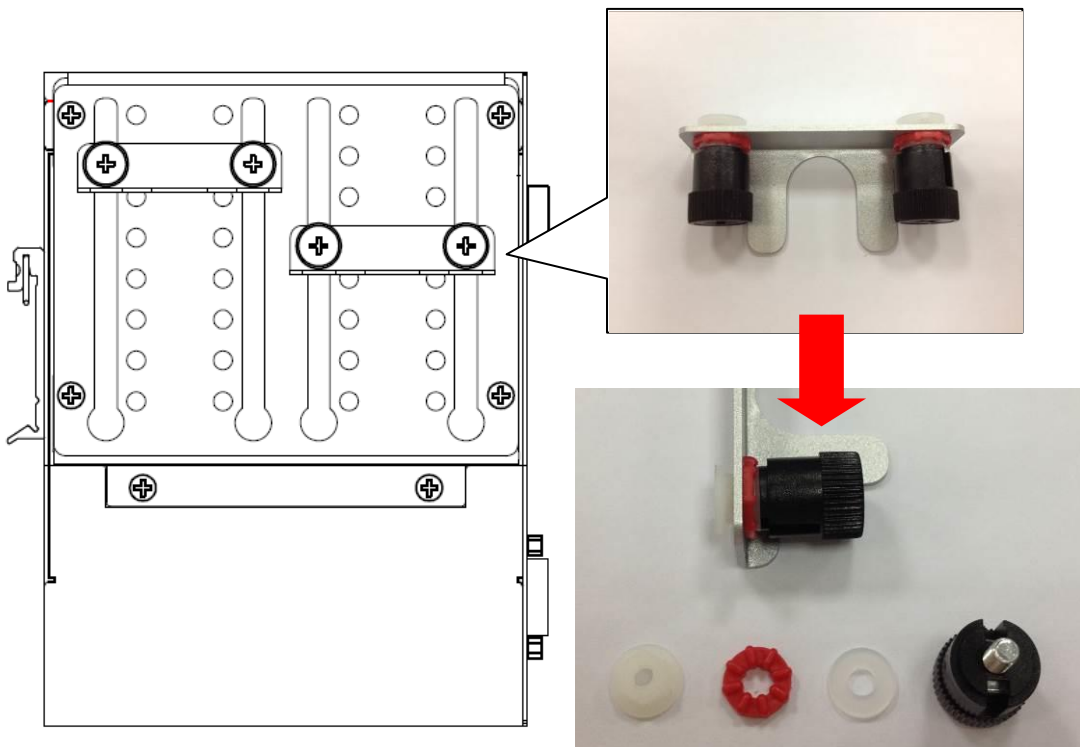

3-8 System Login

There're two methods to login JetBox 5630. One is from web GUI, the other is from Linux console. Detail information please refers to Linux and Web user manual.

➤ **Web GUI**

Login: **admin**

Password: **admin**

➤ **Console**

Login: **root**

Password: (none)

Chapter 4 Customer Service

Korenix Technology Co., Ltd.

Business service: sales@korenixembedded.com, sales@korenix.com

Customer service: koreCARE@korenix.com

Web Site: <http://www.korenixembedded.com>, <http://www.korenix.com>